

SAXDOR

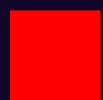

400 GTC

Owner's Manual

Table of Contents

- 1 Welcome on board..... 6
- 1.1 Is this your first boat?..... 6
- 1.2 Your owner’s manual..... 7
 - 1.2.1 Structure of this manual..... 7
 - 1.2.2 Equipment manufacturers’ manuals..... 8
- 1.3 Copyright and disclaimer 8
- 1.4 Definitions..... 9
- 2 Be safe..... 11
- 2.1 Your responsibilities..... 11
- 2.2 Your safety bells and whistles on board..... 12
- 2.3 What is builder’s plate?..... 14
- 2.4 What is design category?..... 15
- 2.5 Avoid emergencies..... 15
 - 2.5.1 Avoid flooding and capsizing..... 16
 - 2.5.2 Avoid grounding..... 17
 - 2.5.3 Move safely on board..... 17
 - 2.5.4 Don’t play with fire..... 17
 - 2.5.5 Consider the carbon monoxide hazard..... 18
- 2.6 Help!..... 19
 - 2.6.1 What if your boat is flooded?..... 19
 - 2.6.2 Actions after grounding..... 20
 - 2.6.3 Man overboard!..... 20
 - 2.6.4 Fire!..... 21
 - 2.6.5 If you suspect carbon monoxide poisoning..... 21
- 3 You’re the captain..... 22
- 3.1 Get going!..... 22
- 3.2 Driving and steering..... 23
 - 3.2.1 Get to know how your boat handles..... 23
 - 3.2.2 What is lanyard stop switch?..... 24
 - 3.2.3 Got the attitude? About trimming your boat..... 24
 - 3.2.4 See where you’re going..... 25
 - 3.2.5 Take it up a notch or a few..... 26
- 3.3 Mooring, towing and anchoring..... 26
- 3.4 Lifting and trailering..... 27

4 The what and where of your boat.....	29
4.1 General boat layout.....	29
4.1.1 Foredeck.....	30
4.1.2 Front cabin.....	31
4.1.3 Main cabin.....	32
4.1.4 Aft cabin.....	33
4.1.5 Aft deck.....	34
4.1.6 Bathing platform.....	35
4.2 User controls.....	36
4.2.1 Helm station controls.....	37
4.2.1.1 Navigation and lighting control panel.....	38
4.2.2 Sofa and table control panel.....	39
4.2.3 Toilet compartment control panel.....	40
4.2.4 High bilge alarm control panel.....	41
4.2.5 Side terrace control panel.....	41
4.2.6 Fuse panel.....	42
4.2.7 Battery control panel.....	43
4.2.8 Shore power panel.....	44
4.2.9 Cooktop control panel.....	45
4.2.10 Temperature control panel.....	46
4.3 Builder's plate.....	46
4.4 Hull identification number.....	47
4.5 Safety on board.....	47
4.5.1 Safety equipment and emergency exits.....	48
4.5.2 Safe seating and moving areas.....	49
4.5.3 Safety labels on board.....	50
4.6 Hull and deck.....	54
4.6.1 Attachment points.....	55
4.6.2 Lifting points.....	56
4.6.3 Hull openings.....	57
4.6.4 Hatches.....	58
4.6.5 Seacocks.....	59
5 The how of your boat.....	60
5.1 Electrical system.....	60
5.1.1 Main switches and indicators.....	61
5.1.1.1 Switching power on and off.....	62
5.1.2 Fuses.....	62
5.1.2.1 Resetting tripped fuses.....	63
5.1.3 Batteries.....	63
5.1.3.1 Charging batteries.....	65

5.1.4 Shore power.....	66
5.1.4.1 Connecting shore power.....	66
5.1.4.2 Disconnecting shore power.....	67
5.1.5 Generator replacement system.....	67
5.1.5.1 Using the generator replacement system and backup power supply.....	70
5.2 Engine and steering system.....	70
5.2.1 Engine.....	71
5.2.1.1 Starting the engine.....	71
5.2.2 Zipwake system.....	71
5.2.3 Bow thruster.....	72
5.3 Fuel system.....	72
5.3.1 Selecting fuel type.....	74
5.3.2 Refueling.....	74
5.4 Draining system.....	75
5.4.1 Using bilge pumps.....	76
5.5 Fresh and waste water systems.....	77
5.5.1 Using the fresh water system.....	78
5.5.2 Using the toilet.....	78
5.5.3 Accessing seacocks.....	79
5.5.4 Using seacocks.....	79
5.5.5 Emptying the waste water tank using the waste discharge outlet.....	80
5.5.6 Emptying the waste water tank using the toilet pump button.....	80
5.6 Navigation equipment.....	81
5.6.1 Accessing the navigation light fixtures.....	82
5.7 Anchor system.....	82
5.8 Comfort and fun.....	83
5.8.1 Heating and air-conditioning.....	84
5.8.2 Wet bar and barbecue grill.....	84
5.8.3 Seating.....	86
5.8.4 Side terraces.....	86
5.8.4.1 Using the side terraces.....	88
5.8.5 Sun shade.....	88
5.8.6 Bathing ladder.....	88
5.8.7 Harbor covers.....	89
5.8.8 Lighting and audio.....	89
6 Respect the environment.....	90
6.1 Handling waste properly.....	90
6.2 Avoiding contaminant spills.....	90
6.3 Minimizing emissions and disturbance.....	90
6.4 Preventing the spreading of aquatic invasive species.....	91

7 Care for your boat..... 92

7.1 Maintaining your boat's gel coat surface..... 92

7.2 Applying antifouling paint to your boat's hull..... 93

7.3 Maintaining canvas covers..... 94

7.4 Maintaining upholstery..... 94

7.5 Cleaning your boat's windshield and windows..... 94

7.6 Maintaining metal components..... 95

7.7 Maintaining lanyard stop switch..... 96

7.8 Maintaining deck floors..... 96

7.9 Maintaining fresh and waste water systems..... 96

7.10 Maintaining bilge pumps..... 97

7.11 Maintaining fuel system..... 97

8 The details..... 98

8.1 Technical specification..... 98

8.2 Boat dimensions..... 100

9 Extras..... 102

9.1 Declaration of conformity..... 102

9.2 Electrical wiring diagram..... 102

9.3 Warranty..... 102

9.4 Warnings and cautions..... 102

9.5 Glossary..... 109

9.6 Customer satisfaction survey..... 111

1 Welcome on board

Congratulations on the purchase of your new Saxdor yacht - the best decision ever made!

Saxdor Yachts welcomes you to the new era of boating! Your Saxdor yacht is built to the highest standards for your pleasure with cutting-edge technologies and attention to safety. Enjoy your new boat's amazing design and high functionality coupled with excellent driving.

This manual is your buddy — not something you stow in the furthest corner of your boat. It contains, together with the equipment manufacturers' manuals, essential information you will need to operate your boat in a safe and enjoyable way. It includes detailed information about the boat and its equipment and accessories, as well as instructions for use and correct maintenance of the boat. Please read the manual carefully and familiarise yourself with your boat before using it.

However, this owner's manual alone is not meant to be a sufficient source of information on safe boating and seamanship. If this is your first boat or if the boat type is not familiar to you, please make sure you obtain sufficient training and experience in handling and using the boat before heading out.

If you sell your boat, please make sure to pass this manual, along with the equipment manufacturers' manuals, on to the new owner.

For more details, see section [1.2 Your owner's manual](#) on page 7.

1.1 Is this your first boat?

We are really happy to welcome you on board as a captain of your first boat — and that being a Saxdor! Let's get you introduced to some important information so your boat can serve you well on every journey, and both you and the boat remain safe and well taken care of at all times.

- Safety first

We cannot emphasize the importance of safety enough. If you're new to the addictive joy of being a captain, please take the time to carefully read sections [2 Be safe](#) on page 11 and [3 You're the captain](#) on page 22. Although your boat is built to the highest safety standards, it is important that you understand the safety aspects of seamanship and have the necessary skills that allow you to enjoy your yacht to the fullest.

- Consider a boating course

If you are new to the world of seafaring, a course on boating safety and seamanship can help you get the right introduction and a feeling of confidence. Your Saxdor dealer or boating society will be able to guide you on this.

- You may need a driver's licence

Some countries require that you have a licence to operate your boat. There may also be specific regulations and carriage requirements in place. Your Saxdor dealer will know about the requirements in your own country.

- Insurance is a good idea, even if not required by law

Insurance can cover for any damage that may occur whenever the boat is being transported and stored, and in use.

Your Saxdor dealer and/or local authorities can provide you with information about insurance requirements in your area. You can also contact insurance companies directly for information on the various alternatives available.

- Registration

In some regions it may be mandatory to register boats of your boat type. Operating the boat may also be subject to holding a license or other qualification. In addition, minimum age requirements may apply.

If unsure, check with your Saxdor dealer.

1.2 Your owner's manual

Learn more about the contents and availability of the user documentation.

The latest version of your manual is always available in the Saxdor share portal. You can check for updated versions for your model year at manuals.saxdoryachts.com.



This manual describes all the options available for this boat model. The configuration on your boat may vary depending on the equipment you have selected, and some of the options may not be available in your region.

The equipment manufacturers' manuals complement this owner's manual. They are included in the Saxdor documentation bag that comes with your purchase.

In case of any difficulties, contact your Saxdor dealer representative for advice and assistance. Saxdor contact information is available at www.saxdoryachts.com.

1.2.1 Structure of this manual

The information you will find in the following sections of this manual is organized as follows.

- Be safe

A guide on the steps you need to take to ensure you, your crew, and your guests remain safe at all times whenever on board.

- You're the captain

Get to know how your boat operates, and take control. This manual is, however, not a course on seamanship or boating safety. For the comfort and safety of both yourself and your crew and guests, please ensure you take a boating and seamanship course, or otherwise gain the handling and operating experience you need, before taking the boat out to sea.

- The what and where of your boat

This section is a graphical presentation of the contents of your boat. See the overall layout and positions of equipment on board at a glance, and discover the different components and control functions in detail.

- The how of your boat

Learn how the systems on your boat work. While this section does give some instructions on how to operate the boat, it doesn't provide full step-by-step instructions on the equipment on board. For these, you need to consult the equipment manufacturers' own manuals.

- Respect the environment
What you can do to keep other persons, the sea and mother nature from harm.
- Care for your boat
This section will give you some guidelines on how to best take care of your boat to ensure a long lifespan and maximum pleasure, but it is not a detailed maintenance guide. Consult the equipment manufacturers' manuals for more detailed instructions. We advise you to always turn to a professional service for the maintenance of your boat.
- When in trouble
Some tips for simple troubleshooting.
- The details
All the technical specifications and the dimensions of your boat.
- Extras
Appendices. Links to the full warranty card, wiring diagrams, and equipment manufacturers' websites. Also a glossary of some important terms, and a summary of warnings and cautions that occur in this manual.

1.2.2 Equipment manufacturers' manuals

The Saxdor documentation bag includes a hard copy of the manuals or quick guides of the equipment that you have selected for your boat.

In case of missing documents please contact your local Saxdor dealer for replacement documents.

1.3 Copyright and disclaimer

Property rights / Copyrights

1. The information included in this document remains the exclusive property of Saxdor Yachts Ltd (hereinafter "Saxdor")
2. Under this document, or in any other act that has been performed in the process of the purchase of the Saxdor boat (hereinafter "Product"), Saxdor does not convey licenses or other rights of any kind, including but not limited to, rights to know-how, patents, utility models, designs, copyrights or other industrial property rights or titles, be it expressed, implied or tacited.
3. Except for the right to utilize the Product and this document, the issuance of the document does not constitute an express or implied grant to any rights to or under Saxdor's patents, copyrights, trade secrets, trademarks or other intellectual property rights. The owner/recipient of this manual and of the Product (hereinafter "User") will not use any tradename, trademark, logo or any other proprietary rights of Saxdor or any of its affiliates in any manner without a prior written authorization of such use by a duly authorized representative of Saxdor.
4. The User is prohibited from registering his/hers own industrial property rights, such as patents, registered design or utility models, on the basis of the information obtained or received with this document or in connection with the Product purchase, as well as otherwise exploit the information included in this document for commercial gain.

Disclaimer

1. This document is provided "as is". The information in this document is believed to be accurate and reliable. However, Saxdor is not responsible for the content of this document, insofar as legally permissible, and makes no representations or warranties, express or implied, as to the accuracy or

completeness of such information and shall not be liable for the consequences of the use of the information included.

2. This document, unless explicitly otherwise indicated, does not include any implied warranties of satisfactory quality, merchantability, fitness for a particular purpose, compatibility or non-infringement.
3. Saxdor reserves the right to make changes to the information published in this document, including without limitation specifications and product descriptions, at any time and without notice.
4. This document supersedes and replaces all information supplied prior to the publication hereof.
5. Saxdor products are not designed, authorized or warranted to be suitable for applications where failure or malfunction could result in personal injury, death, or serious property or environmental damage. Saxdor is not responsible for the incorporation and/or use of its products in such situations or applications, and therefore, such inclusion and/or use is at the User's own risk.
6. Neither Saxdor nor anyone else who has been involved in the creation, production or delivery of the Product shall be liable for any special, indirect, consequential, incidental or punitive damages (including, but not limited to, lost revenues, profits and/or savings) arising from reasonably improper use or inability to use the Product, even if Saxdor has been informed of the possibility of such damages or claims.

1.4 Definitions

See here the conventions used in this manual.

Measurement units

Measurement units are, in general, given in accordance with the International System of Units (SI) and the United States Customary Units (USCS). USCS units used in this manual has been calculated from the original SI units. Exceptions:

- Wind force is given in the Beaufort scale (BFT)
- Speed is given in knots (kn).

Figures

All figures are shown for illustration purposes only. Actual product may vary depending on the selected optional features and equipment.

- Details framed in solid red line illustrate areas and equipment locations on your boat.
- Details framed in dotted red line refer to areas or equipment which are inside your boat or not directly visible in the figure.
- Green arrows indicate emergency exits.
- Filled orange circles refer to designated passenger seats.
- Filled orange area with diagonal lines illustrates the working deck area.

Safety symbols

Warnings and cautions are labeled in accordance with the international ISO and ANSI standards.



Indicates an imminently hazardous situation which, if not avoided, will result in death or serious injury.

⚠ WARNING

Indicates a potentially hazardous situation which, if not avoided, could result in death or serious injury.

⚠ CAUTION

Indicates a potentially hazardous situation which, if not avoided, may result in minor or moderate injury.

NOTICE

Indicates a potential situation which, if not avoided, may result in property damage or in an undesirable result or state.



Gives additional information or calls for attention to the correct use of the product, to the expectations of the user, or to how to avoid error situations.

2 Be safe

A guide on the steps you need to take to ensure you, your crew, and your guests remain safe at all times whenever on board.

2.1 Your responsibilities

Safety is the first step and most important step towards getting maximum pleasure out of your boat. Please familiarize yourself with the contents of this chapter before taking your boat out to sea for the first time.

As the captain of your boat, you have the ultimate responsibility! Not just for yourself, but also for your crew, any guests on board and other seafarers.

⚠ WARNING

Risk of collision.

Do not operate the boat outside of inland waterways in foggy conditions, in poor visibility or at night.

⚠ WARNING

Neglecting the necessary safety precautions can risk lives.

Take safety seriously. Remember that you as the driver are responsible for the safety for others.

⚠ CAUTION

Risk of injury or material damage.

The owner is responsible for ensuring that the normal mode of operation is maintained. This means that the speed of the craft needs to be matched to the prevailing sea state, the craft being used with good seamanship behavior.

Behave responsibly!

- Make sure you and any other persons who will operate your boat have the necessary boating and navigation skills.
- Check that all persons on board, yourself inclusive, are wearing a life jacket at all times.
- Do not let anyone swim around the boat when the engine is running.
- Load the boat correctly within capacity limits.
- Don't drink and drive.
- Do not climb on the roof or use the engine as a stepping platform.
- Be aware of and make sure you comply with all applicable local laws and regulations.
- Make sure the safety equipment complies with local regulations.
- Take good care of your boat and have it serviced regularly. Don't attempt to perform any major repairs by yourself or make modifications to your boat without consulting your Saxdor dealer first.
- Read this manual and the documentation supplied in the Saxdor documentation bag and heed the warnings and cautions in them.

Be prepared!

- Know your boat and understand the safety limitations set on your boat by capacity and design category.
- Proactively maintain your boat to keep it in good condition. Keep an eye on any signs of wear and tear and have them repaired immediately.
- Familiarize yourself with the location of all safety equipment on board, and check that they are fully functional before setting off.
- Make sure you understand all emergency procedures.
- Also make sure that everyone on board is familiar with the correct use and operation of all safety equipment in the event of an emergency.
- Check the weather conditions and forecast before you set off.
- Plan your route and stopovers, and make sure you have the equipment and facilities needed.
- Make sure you are familiar with local laws and regulations concerning reporting accidents.

Be aware of risks and know how to act

Boating always comes with certain risks. Make sure you know how to minimize these risks, and be prepared to act in the event something were to happen.

Learn more

- How to be prepared: [2.5 Avoid emergencies](#) on page 15
- How to act in case of emergency: [2.6 Help!](#) on page 19

2.2 Your safety bells and whistles on board

To ensure carefree and safe boating, your boat is equipped with different safety fixtures. Familiarize yourself with them before setting off on your voyage for the first time.



There maybe different or additional requirements for safety equipment in your country. In some countries it is a legal requirement to wear a life jacket.

This kind of additional safety equipment is not Saxdor's responsibility. Also, it is your responsibility to ensure that the equipment complies with local regulations and that these devices are fully functional. If unsure, consult your Saxdor dealer.

Builder's plate

Start with the builder's plate! It contains important safety information, such as maximum load and number of people, which you must abide by at all times.

Safety equipment and emergency exits

Your boat comes with emergency exits, a CO detector and space reserved for additional safety equipment. Your Saxdor dealer will help you get the additional safety equipment required in your country, such as fire extinguishers and smoke detectors. Take note that safety the equipment may require periodic service or replacement.

Recommended additional safety equipment:

- Cell phone with waterproof case
- Spare batteries
- Waterproof GPS, VHF radio, EPIRB, compass
- Ditch kit, first aid kit
- Survival suit, thermal clothing
- Emergency food and water
- Ring buoy, life jackets, life raft, whistle, mirror, flashlight
- Spare anchor and anchor lines, spare mooring and towing lines
- Fenders and boat hook
- Spare propellers and hardware, spare parts and equipment (pumps, filters, engine oil, fuses) and tool kit.

Life jacket

Life jackets must be stored in an easily accessible location and must be ready for immediate use. Inform all passengers of the location of the safety equipment. Take note that children, disabled people and non-swimmers may need special type of life jackets or special attention and instructions in use of safety equipment. Before setting off, read all necessary instructions provided by life jacket manufacturer.

⚠ WARNING

Risk of drowning.

Neglecting to carry onboard and use life jackets in emergency can cause death and serious injury.

Make sure that your boat is equipped with proper number and type of life jackets.

Make sure that all persons on board, including yourself, are wearing a life jacket at all times.

Life raft

Larger boat may need a life raft. Always store the life raft in the location designated for it. If there is no specific storage place, store the life raft in unobstructed and accessible area.

Read the manufacturer's instructions for deployment, storage and maintenance.

Precautions

Before setting off, make sure:

- All safety equipment is fully functional and easily accessible.
- Everyone on board knows where to find the safety equipment and emergency exits.
- Everyone knows how to use the equipment and how to act in an emergency.
- Everyone wears a life jacket, even if not required by law.

Maintain your safety equipment

- Have the fire extinguisher inspected at the intervals indicated on the device or according to the local legislation. Replace the fire extinguisher if it has been expired.

⚠ WARNING Risk of fire or explosion.

When replacing parts of the fire-fighting installation only matching components shall be used, bearing the same designation or being equivalent in their technical and fire resistant capabilities.

- Test the operation of smoke and CO detectors according to the local legislation.

Safety labels

Your boat is equipped with labels containing important safety information. Make sure:

- You and everyone on board understands the meaning of the safety symbols and the texts on the labels.
- Everyone obeys the instructions on the labels.

Related information

[4.3 Builder's plate](#) on page 46

[4.5.1 Safety equipment and emergency exits](#) on page 48

[4.5.3 Safety labels on board](#) on page 50

2.3 What is builder's plate?

The builder's plate is an certification label and proof of the consistent, high standard of Saxdor yachts. The type of builder's plate vary dependent on the local governing authority.

The builder's plate on your boat is located close to the steering wheel and contains important safety information such as:

- Your boat's design category
- Load capacity (not including fuel)
- Maximum permitted number of persons, engine weight and power
- Boat builder's contact details

The plate also shows the boat builder's contact details.

⚠ DANGER Not heeding the limitations stated on the builder's plate can cause boat capsizing, swamping or sinking.

Do not exceed the maximum permitted engine power or number of persons on board.

Respect the conditions set out by the design category of your boat.

Related information

[4.3 Builder's plate](#) on page 46

2.4 What is design category?

Design category is an important element of safe boating! It defines the weather and nautical conditions in which it is safe to operate your boat.

⚠ WARNING

Not respecting the design category limitations of your boat can put you and your passengers at risk.

Do not exceed the maximum permitted engine power or number of persons on board.

Ensure that the anticipated wind and sea conditions correspond to the design category of your boat.

Always make sure your boat and your operating skills match the weather and water conditions where you are going to operate.

Design category conditions are specified using maximum wind speed and maximum significant wave height as measurement. A significant wave height refers to the average height of the highest one third of all waves, visually estimated.

For example, design category C conditions are typically encountered in exposed inland waters, estuaries and coastal areas in moderate weather conditions. Design category B conditions are more severe — typically encountered offshore, but also in coastal areas and larger inland waters where sheltered areas are not readily available.

Table 2.1 - Design category specification

Description	Category A		Category B		Category C		Category D	
Wind force	Beaufort force exceeding 8		Beaufort force 8 or less		Beaufort force 6 or less		Beaufort force 4 or less	
Significant wave height	>4 m	>13 ft	≤4 m	≤13 ft	≤2 m	≤6.6 ft	≤0.3 m	≤1 ft

What is my boat's design category?

Your boat's design category is indicated on the builder's plate. You can also check it from the Technical specification in this manual.



Your boat's design category is B. So please make sure you follow the safety rules, for example:

- For category B conditions, you can have the maximum number of passengers indicated on the builder's plate on board.

2.5 Avoid emergencies

Know what the risks are, act responsibly, and have a plan.

2.5.1 Avoid flooding and capsizing

Don't compromise stability!

Do not worry! Your boat is designed to be very stable and does not get easily flooded.

Also, remember that when boating, it is normal to get water into the boat. To keep your feet nice and dry, and the boat afloat, there are several drainage openings in the hull. Automatic bilge pumps work non-stop to keep the bilge clear of water. A manual pump complements the automatic pump.

However, stability can be compromised by many things such as rough waters, towing, poorly balanced load and too much water in the bilge. Take these steps to maximize stability:



1. Load your boat right.

- Respect the design category limitations on the number of persons on board.
- Make sure everybody on board is seated in the designated seats.
- Do not exceed the maximum allowed load on the builder's plate.
- Make sure all equipment, accessories and luggage items are stowed and will stay securely in place even in rough sea conditions and strong winds.

WARNING

Any change in the weight distribution may significantly affect the stability, trim and performance of the boat.

When loading the boat, never exceed the maximum recommended load. Always load the boat carefully and distribute loads appropriately to maintain design trim (approximately level). Avoid placing heavy weights high up.

Take into account any modifications that may affect weight distribution, such as a different engine or a fishing tower.

WARNING

Getting entrapped in the cabin and not having quick access to safety equipment can be fatal in case of flooding.

Never lock or block the access to the emergency exits or safety equipment.

Do not store luggage or other heavy items on top of the front deck hatch.

2. Close side terraces, doors and hatches while under way.

- Always lock the side terraces in upright position before you set off.
- Always keep all hatches and storage locker lids closed while under way.
- Keep portlights, windows, washboards, doors and ventilation openings closed in rough weather or at planing speed.

WARNING

Getting water into the hatches or inside the boat increases the risk of flooding.

Always keep hatches closed and side terraces in upright position when under way.

3. Keep the drain outlets functional and monitor water levels.

- Always keep the drain holes open. The only time you may close them is in a situation where water starts getting into boat during loading.

- Clear the pump inlets from debris if needed.
- If the seacocks are fitted in the front and aft peak bulkheads, keep them closed. You may only open them in order to let water drain into the main bilges.
- If you notice that there is more water than usual in the bilge, or if you get the high bilge water alarm, check your boat for leaks and damage to the hull. Use the manual bilge pump to pump out the excess water.

 **WARNING** Risk of flooding.

Getting water inside the boat increases the risk of flooding.

Keep seacocks closed when not needed for operation to minimize the risk of flooding (for example water inlet of toilet flushing line).

2.5.2 Avoid grounding

Shallow waters bring dangers such as sand or rocks. Pay attention to marker buoys and observe your surroundings at all times.

 **DANGER** Risk of death, serious injury or severe damage to your boat.

Sudden grounding from high speeds can cause serious injury or death and severe damage to your boat.

Rapid deceleration can cause occupants to crash the boat and to be ejected from the boat.

Be aware of your boat's minimal safe depth to avoid grounding.



- Be aware of the local conditions and water depth.
- Drive slowly and with caution when you are in an area you are not familiar with.
- Always check the water depth to avoid grounding.

2.5.3 Move safely on board

To ensure your safety, your boat has designated areas for moving on board and sitting while using the boat.

- Use the working deck area when mooring and leaving the shore.
- Ensure that everyone on board is seated in the designated seating areas during voyage. Do not exceed the maximum allowed number of persons on board.

Related information

[4.5.2 Safe seating and moving areas](#) on page 49

2.5.4 Don't play with fire

Avoid situations that can cause a risk of fire.

Make sure you are familiar with the location of safety equipment and emergency exits on board.

⚠ WARNING Risk of fire or explosion.

Handle open flame and fuel-driven devices with caution.

⚠ WARNING Careless refueling is a fire hazard.

Never fill the fuel tank or handle fuel when the engine is running.

Don't smoke when handling fuel.

To minimize the risk of fire, always take these safety measures:



- Be careful not to damage fuel lines.
- Never store fuel containers or equipment containing fuel in any area not designated for the purpose.
- Never obstruct access to the fuel tank compartment, safety controls, electrical systems, ventilation units, safety equipment or passageways to fire exits and hatches.
- Don't make changes to your boat's electrical, ventilation or fuel systems yourself.
- Never leave the stove or heater unattended or have any free hanging curtains or other fabrics near them.
- Check the bilge regularly to make sure that there are no fuel leaks.
- When replacing safety equipment, make sure it complies with local requirements.

⚠ WARNING Risk of fire or explosion.

When replacing parts of the fire-fighting installation only matching components shall be used, bearing the same designation or being equivalent in their technical and fire resistant capabilities.

Related information

[4.5.1 Safety equipment and emergency exits](#) on page 48

2.5.5 Consider the carbon monoxide hazard

Carbon monoxide (CO) is an odorless but potentially lethal gas! Be aware of and avoid situations in which there is a risk of CO accumulation.

⚠ WARNING Carbon monoxide (CO) is harmful to your health in higher concentrations, and can even be lethal. Even low concentrations of CO can cause damage with prolonged exposure.

Prevent the accumulation of CO in the first place by minimizing the risk situations.

Act quickly if the CO alarm turns on or if you suspect CO poisoning.

Be aware of CO poisoning signs, such as irritated eyes, headache, nausea, weakness and dizziness, and seek medical attention if necessary.

Engine exhausts contain carbon monoxide (CO). High CO concentrations can occur especially when:

- Running the engine in confined spaces in a standstill, for example with the boat close to another vessel or with the engine next to a wall.
- Driving at slow speeds or in a tailwind.
- Driving with the bow high.
- Running the engine with the cabin door open may cause exhaust fumes to enter the cabin.

To prevent CO accumulation:



- Do not rev or idle the engine unnecessarily, for example when mooring or when there are persons in the water.
- Do not block exhaust outlets and inspect the exhaust system regularly.
- Ensure all areas on the boat are kept well ventilated if you're using a diesel heater or any other fuel-burning device.
- Keep the cabin door closed when running the engine.
- Leave enough space between the engine and any obstacle.

Related information

[2.6.5 If you suspect carbon monoxide poisoning on page 21](#)

2.6 Help!

Even though you try to avoid it - emergencies do occur. Being prepared and knowing how to act is the best way to prevent them from getting serious.

⚠ WARNING

Trying to cope by yourself too long can quickly escalate an emergency.

In case you cannot handle the situation, always contact rescue service without delay!

2.6.1 What if your boat is flooded?

When boating, it is normal to get some water into the boat. However, if water starts to accumulate, you need to take action.

⚠ WARNING

Risk of drowning!

The boat can sink or capsize if too much water gets into the boat as the bilge pump system can not remove it all.

The bilge pumping system is not designed for damage control. The combined capacity of the system is not intended to drain the craft in case of damage.



- If you suspect a leak, act quickly.
 - If there is a rapid increase in water accumulation, call rescue service.
 - If you have moderate accumulation of water, reduce the flooding manually. Use the manual pump or a bail.
- Make sure everyone is wearing a life jacket.

- Find out the reason and go ashore as soon as possible.

Related information

[2.5.1 Avoid flooding and capsizing on page 16](#)

[4.5.1 Safety equipment and emergency exits on page 48](#)

[5.4 Draining system on page 75](#)

2.6.2 Actions after grounding

In the event of grounding, keep calm.

WARNING

Risk of serious injury or death.

Any leak, especially a serious one, can cause the boat to sink quickly.

Wear a life jacket at all times and evacuate immediately from a sinking boat.

Your future actions depend on how hard the boat hits the bottom or rocks. If a light bottom contact occurs, you may only need to inspect the hull for damages. Follow the below instructions:



- Stop the engines and lift them out of the water.
- Make sure that all passengers are in the boat and wear life jackets.
- If possible and necessary, call and inform the authorities.
- Check the bilge for leaks.
If a leak is detected, close all the doors and hatches to minimize water accumulation. Remove the water by using the manual bilge pump.
- Turn all the main electrical switches to OFF position.
- Inspect the overall condition of the boat, steering system and engines. Check if there are any damages or leaks.
Do not drive if you detect any leaks from the engines to avoid damaging the engines further.
- Prepare the life raft for use, if equipped and necessary.
- Evacuate yourself and all passengers, if necessary.
- Maneuver the boat to safe waters or nearest shore, if the hull and all operating systems are in good condition.
Make sure that changing the gear to reverse does not cause or increase damages.
- Have the boat checked by a professional service after grounding.

2.6.3 Man overboard!

If a person has fallen into the water.



- Point the boat directly into the wind.
- Stop the engine if it is running.
- Hand the person a flotation device if they are not wearing one.
- Help the person back on board. You can lower the bathing ladder for the purpose.

⚠ WARNING Risk of injury.

Do not use the outboard engine's cavitation plates for reboarding.

Related information

[4.1.6 Bathing platform](#) on page 35

[5.8.6 Bathing ladder](#) on page 88

2.6.4 Fire!

Don't waste time!



- Turn off power from all the power sources.
- Close the fuel valve.
- Check that everyone is wearing a life jacket.
- Use a fire blanket or fire extinguisher to put out the fire. Do not use water!

⚠ WARNING Risk of explosion.

Never use water to put out fuel fire. If the fire gets in touch with a flammable fuel, water can spread the fire and cause an explosion.

- Don't hesitate to call for help and evacuate the boat if the fire starts spreading.

2.6.5 If you suspect carbon monoxide poisoning

If a person has been exposed to carbon monoxide, act quickly!

⚠ WARNING Carbon monoxide (CO) is harmful to your health in higher concentrations, and can even be lethal. Even low concentrations of CO can cause damage with prolonged exposure.

Prevent the accumulation of CO in the first place by minimizing the risk situations.

Act quickly if the CO alarm turns on or if you suspect CO poisoning.



- If the CO alarm turns on:
 - Turn off the engine(s) and all possible devices.
 - Do not use fire or any electronics.
 - Open all the ventilation hatches and doors.
- If a person shows signs of CO poisoning (headache, dizziness, ringing in the ears, nausea, loss of consciousness):
 - Move the person to a well ventilated area and have them breathe fresh air deeply.
 - If breathing has stopped, call rescue service and resuscitate!

3 You're the captain

In this section of the manual we will help you understand how to operate a boat and how to take control.

This manual is, however, not a course on seamanship or boating safety. For the comfort and safety of both yourself and your crew and guests, please ensure you take a boating and seamanship course, or otherwise gain the handling and operating experience you need, before taking the boat out to sea.

3.1 Get going!

You're raring to go, and so is your boat! But before you set off, ensure that you've gone through all the relevant checks.

- Check the weather forecast. Consider the prevailing wind force, wave profile and visibility. Don't exceed the capabilities of your boat's design category.
- Make sure you and your crew have the necessary boating and navigation skills. Agree on the duties for each person before approaching and leaving the shore.
- Make sure you load your boat right. Ensure that your load, including the number of passengers, does not exceed the maximum limit of your design category.
- Check you have all the necessary equipment such as life jackets for all passengers, mooring lines, fenders, functional safety equipment and a compass. Have a print copy of your charts covering a sufficiently large area.
- Refuel the boat and make sure you use the right type of fuel. Check the engine manual, if in doubt.
- Inspect the engine as specified in the engine manual.
- Be prepared for unexpected situations with extra fuel and provisions. Not to forget spare batteries for equipment like phones and flashlight.
- Check that all the critical equipment such as the steering system, navigation lights, horn and bilge pumps are functional.
- Check that the drain seacocks are open, other seacocks closed, hatches closed, and bilge clear of water and fuel.
- Ensure sufficient ventilation of the fuel compartments to reduce the risk of fire. Make sure ventilation channels are unobstructed.
- Make sure you know and obey the right-of-way rule and other navigation rules defined in the International Regulations for Preventing Collisions at sea (COLREG).



When filling the fuel and fresh water tanks, remember that you may not be able to fill up the tanks all the way if the boat is not level due to the trim or an uneven load trim. Therefore, always keep an extra 20% reserve.

Related information

[2.1 Your responsibilities](#) on page 11

[2.4 What is design category?](#) on page 15

[2.5.1 Avoid flooding and capsizing](#) on page 16

3.2 Driving and steering

All aboard? Check out these tips and get cruising!

3.2.1 Get to know how your boat handles

Your boat has its own unique behavior. Learn to know her before entering crowded waters or docks.

Maneuvering the boat

- First practice controlling your boat in open and protected water with enough space.
- Learn how your boat responds to wind, waves and currents from different directions.
- Avoid sudden maneuvers at speed.
- Always be certain you have sufficient distance to stop or maneuver if required to avoid collisions.
- When approaching or leaving the shore, apply the throttle in sharp and short doses to make your steering maneuvers efficient. Avoid sudden steering movements and make sure that all crew members not required to assist in the docking remain seated.
- Practice trimming until you are comfortable using it.
- If you have a twin engine model, practice docking and other behaviors specific to twin engines.
- If you are the driver and must leave the helm station, make sure to shift the engine into neutral.

Using the engine throttle and shift control

- Start the engine(s) and attach the lanyard stop switch cord to yourself.
- Shift to forward or reverse as necessary to get out of the dock.
- When you leave the dock, maneuver and gradually add speed as necessary.
- Always stop at the neutral position and allow the engine idle speed to stabilize before you shift into another gear. Shift into gear with a quick motion.
- Push the control handle gently forward or back until you reach the desired speed.
- Gently pull the control handle back to neutral position when you want to slow down.
- Learn how to trim the boat with the throttle and shift control.

NOTICE

Risk of severe engine damage! Shifting the engine into reverse at forward speeds higher than idling speed could cause the engine to stall and allow water to enter the engine's cylinders.

Drop the speed to idling speed before you shift into reverse.

Related information

[3.2.3 Got the attitude? About trimming your boat on page 24](#)

[3.2.5 Take it up a notch or a few on page 26](#)

[5.2.1.1 Starting the engine on page 71](#)

3.2.2 What is lanyard stop switch?

Don't want your boat to ride without a driver? The lanyard stop switch comes to the rescue.

WARNING

Risk of injury or severe damage to your boat.

A malfunctioning lanyard switch can cause the engine to shut down unexpectedly or fail to shut down when needed.

Do not operate the boat if the lanyard stop switch does not function properly. Lanyard stop switch should be used in emergency situations only.

The lanyard stop switch shuts down the engine if the driver moves too far from the helm station, or falls overboard. The switch with the lanyard is located at the helm station.



The switch doesn't work if the driver is not hooked onto it!

- Always attach the lanyard to yourself immediately after having released the mooring lines.
- Don't forget to release the lanyard when docking so that the engine doesn't stop unintentionally.

Check the engine manufacturer's manual for more details about using the lanyard stop switch.



You may have an option for a wireless lanyard stop switch. If you have this feature, you may use it instead of the fixed lanyard stop switch.

Related information

[4.2.1 Helm station controls](#) on page 37

3.2.3 Got the attitude? About trimming your boat

Learn how to trim your boat in order to ensure a smooth cruise and optimal performance.

The trim, or attitude, of your boat is its running angle as it makes way in the water. Running in the wrong trim angle gives you a bumpy ride and loads the engine unnecessarily. Learn how to:

- Adjust the boat's vertical running angle (raise or lower the bow) when getting to planing speed or changing speeds.
- Play with your trim until you find the most comfortable ride while cruising.
- Adjust the boat's heel (lateral angle) when travelling in a crosswind or with an unbalanced load.

You can trim your boat with the joystick at the helm station. By trimming you can adjust:

- The boat's vertical running angle.
- The boat's heel.

You can also trim your boat's vertical angle using the engine throttle and shift control. Trimming changes the propeller shaft angle, which causes the bow to move up or down.

⚠ WARNING

Poor trimming can risk lives! Adjusting the trim angle at high speeds may radically affect your boat's behavior. A high running trim can obstruct the view so you may not notice swimmers and small vessels.

Avoid making adjustments at high speeds.

Don't drive with the bow high for long periods of time. Trim the boat's vertical angle to lower the attitude in congested areas.

See the trim tab manufacturer's manual for detailed instructions on how to use the trim tabs.

See also the engine manufacturer's manual.

Related information

[4.2.1 Helm station controls](#) on page 37

[5.2 Engine and steering system](#) on page 70

3.2.4 See where you're going

To avoid any unexpected dangerous situations, ensure you're always able to see where you are going and what is happening around your boat.

- Make sure that nobody or nothing is blocking the view from the helm station. Pay special attention to the following factors as these may reduce the visibility:
 - Propulsion unit trim angles
 - Hull trim plane angles
 - Loading and load distribution
 - Speed
 - Rapid acceleration
 - Transition from displacement to planing mode
 - Sea conditions
 - Weather conditions, (for example rain, darkness and fog)
 - Interior lights
 - Position of tops and curtains
 - Persons or movable gear in the driver's field of vision.
- Be aware that a high running trim can obstruct the view so you may not notice swimmers and small vessels. Don't drive with the bow high for long periods of time and trim the boat to lower the attitude in congested areas.
- Turn on the navigation lights when it is dark or the visibility is poor.
- Find out beforehand how the windshield wiper works.

3.2.5 Take it up a notch or a few

Despite your Saxdor boat's wow performance, you will resist the urge to show off driving at full speed — being the responsible person you are.

⚠ WARNING

Overcorrecting, dropping the speed suddenly or hitting the waves at a wrong angle when driving at high speeds can have serious consequences.

Do not exceed your boating capabilities. Drive at speeds you are comfortable with. Avoid sudden maneuvers.

Always use the lanyard stop switch.

Respect the boat's and your own limits

- The faster you drive your boat, the less of it is connected to the water, and this means the boat feels more responsive to even your small adjustments. At high speed you have less control over your boat at the beginning of a turn.
- Be careful with trimming at high speeds. Don't drive with the bow down.
- When driving in planing mode the boat lifts off the water surface and the air draft increases. Reduce speed when driving under low obstacles such as bridges.
- Do not drive at maximum speed while in congested high traffic waterways, high winds, large waves or when visibility is reduced.
- Do not exceed the maximum recommended engine power shown on the builder's plate and in Technical specifications.
- Secure loose equipment safely when underway.

Be considerate

- Reduce your speed and wake as a courtesy and as a safety consideration to yourself and others.
- Observe and obey the speed limits.
- Respect no wake zones to protect the environment.

3.3 Mooring, towing and anchoring

Check here for tips about mooring, towing and anchoring.

Practice the techniques

- Practice mooring in calm weather, and use large enough fenders.
- Always tow or be towed at a slow speed. Never exceed the hull speed of a displacement boat when being towed.
- When anchoring, make sure you anchor far enough from the shore, and a sufficiently long rope to get a good hold.
- Always lift and secure the anchor when you are not using it.

Strong points for attachment

Your boat has several cleats to be used as strong points for mooring, towing and anchoring.

- When you tow another boat, use the aft cleats.
- When your boat is towed, use the bow cleats.



Some boat models have a separate towing plate in the bow, which you can also use for towing your boat.

- Always use at least two cleats and big enough fenders when mooring at a dock to prevent the boat from moving and scraping against other boats or structures onshore.
- Do not exceed the breaking strength of the strong points. See Technical specification for details.

Mooring, anchoring and towing lines

- Ensure that mooring lines, towing lines, anchor chains, anchor lines and anchors are adequate for the boat's intended use. The lines or chains must not exceed 80 % of the breaking strength of the respective strong point. Preferably, use the towing and mooring lines provided in the mooring package of your boat. If you are unsure what kind of equipment to use, contact your Saxdor dealer.
- Always attach the lines so that they can be released when under load.
- Make sure your mooring lines and fenders are ready at hand for docking.
- Make sure the lines and chains don't get tangled in the propeller.

Related information

[4.6.1 Attachment points](#) on page 55

[5.7 Anchor system](#) on page 82

3.4 Lifting and trailering

Treat your boat well even on land.

You and your boat would rather be on the water, but sometimes you need to lift and transport your boat for maintenance, out-of-the-season storage, or to another location.

It is recommended you use a professional service, unless you're skilled enough and have the right type of equipment for the task.

Lifting

CAUTION

The boat may tip or the lifting straps may slide during lifting if the straps are not attached properly or if the loads move and disturb the balance of the boat.

Empty the bilge and waste water tanks and remove any unnecessary load from the boat.

Do not hook the boat through the aft wings as the straps may slide away.

- Lift the boat only from the recommended lifting points.
- Always use spreader bars when lifting the boat. They distribute the weight of the boat over the two lifting points. Make sure the spreader bars are long enough to protect the hull and side terraces from damage.

Trailing

⚠ CAUTION

Trailing a large load can be a traffic hazard.

Use a trailer that is suitable for the boat.

Do not exceed the trailer capacity.

Secure the boat and the trailer properly.

- Make sure to remain within the limits of the maximum mass indicated in Technical specification (m_T).
- Make sure your vehicle is powerful enough and you know how to maneuver the trailer.
- Use the cleats in the bow of your boat to pull your boat onto a trailer.
- Attach the boat to the trailer from all cleats of your boat.

Related information

[4.6.2 Lifting points](#) on page 56

4 The what and where of your boat

Here you can see the overall layout, the equipment and the features of your boat in pictures.



The following images describe the options available for this boat model. The configuration on your boat may vary depending on the equipment you have selected, and some of the options may not be available in your region.

4.1 General boat layout

Get an overview of the general layout of your boat and become familiar with the different compartments.

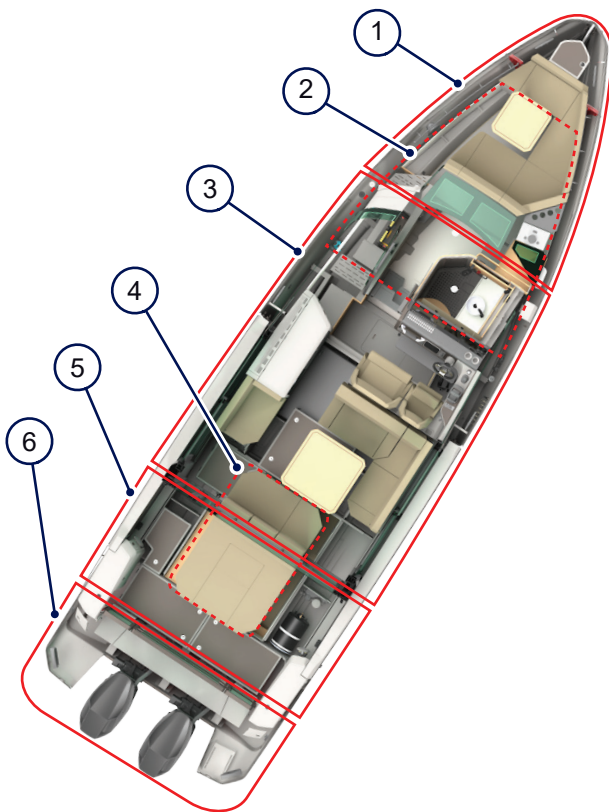

Figure 4.1 - General boat layout

- | | | | |
|---|-------------|---|------------------|
| 1 | Foredeck | 4 | Aft cabin |
| 2 | Front cabin | 5 | Aft deck |
| 3 | Main cabin | 6 | Bathing platform |

4.1.1 Foredeck

See here what you can find on the foredeck.

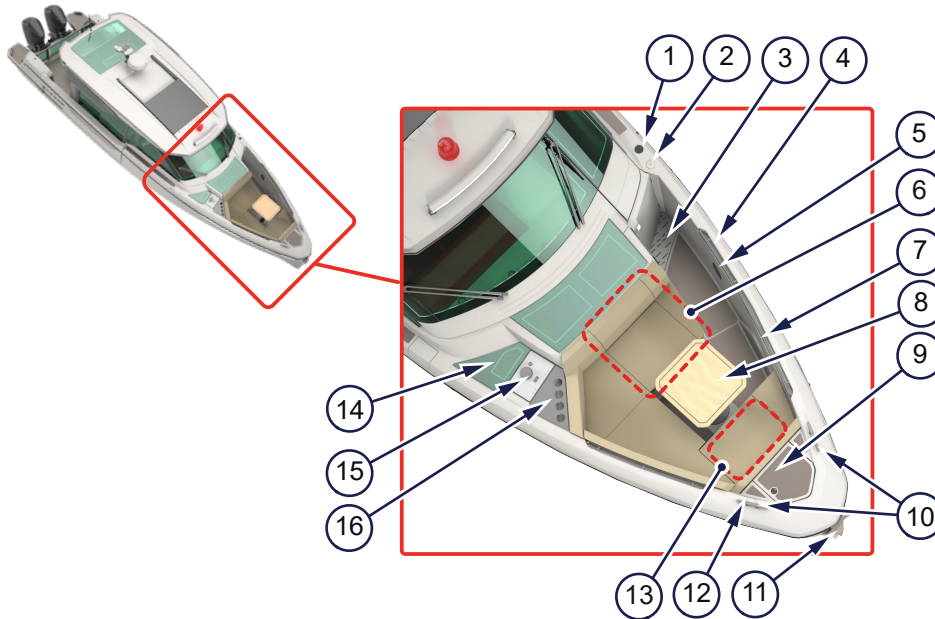

Figure 4.2 - Foredeck

- | | | | |
|---|---------------------------------------|----|------------------------|
| 1 | Fresh water inlet | 9 | Anchor box hatch |
| 2 | Gasoline fuel inlet | 10 | Bow cleats |
| 3 | Foredeck drainage | 11 | Anchor |
| 4 | Handrails | 12 | Sun shade mountings |
| 5 | Speaker | 13 | Storage box hatch |
| 6 | Emergency exit (from the front cabin) | 14 | Front cabin skylight |
| 7 | Deck lights | 15 | Ventilation hatch |
| 8 | Table and sofas | 16 | Cup and bottle holders |

4.1.2 Front cabin

See here what you can find in the front cabin.

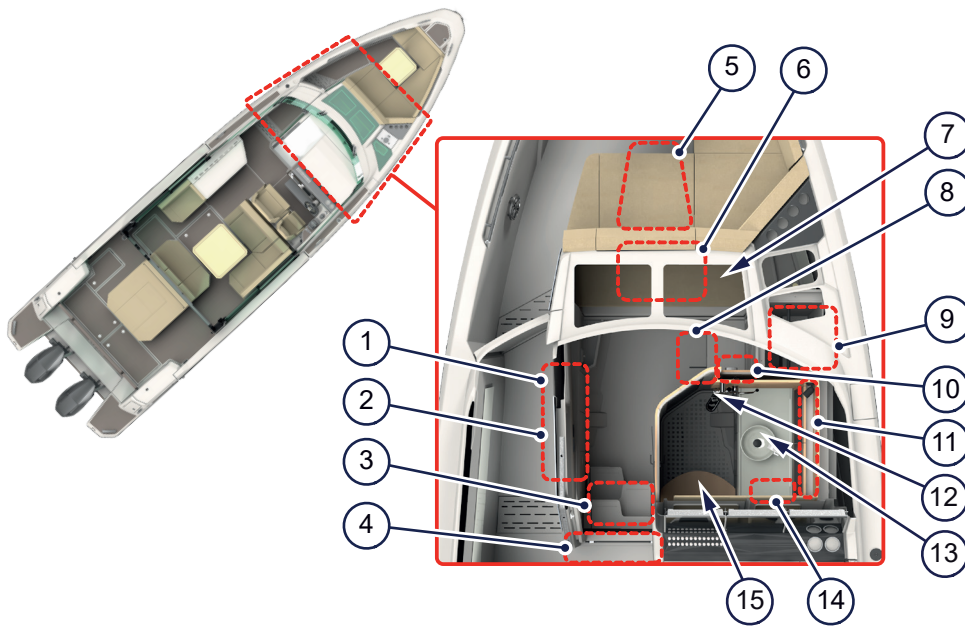

Figure 4.3 - Front cabin

- | | | | |
|---|--|----|---|
| 1 | Temperature control panel, audio control panel | 9 | Smoke and carbon monoxide (CO) detector |
| 2 | Fuse panel, power outlets, light switch | 10 | Wardrobe |
| 3 | Shower's grey water box and bilge pump hatch | 11 | Mirror cupboard |
| 4 | Kid cabin hatch (AC pump, black water valve, sea strainers) | 12 | Fresh water shower |
| 5 | Storage under the bed | 13 | Fresh water tap, sink, bidet shower |
| 6 | Cabin technical compartment hatch (bow thruster and battery) | 14 | Toilet compartment control panel |
| 7 | Bed | 15 | Toilet and toilet compartment |
| 8 | High bilge alarm panel | | |

4.1.3 Main cabin

Check here the facilities and equipment that you can find in the main cabin.

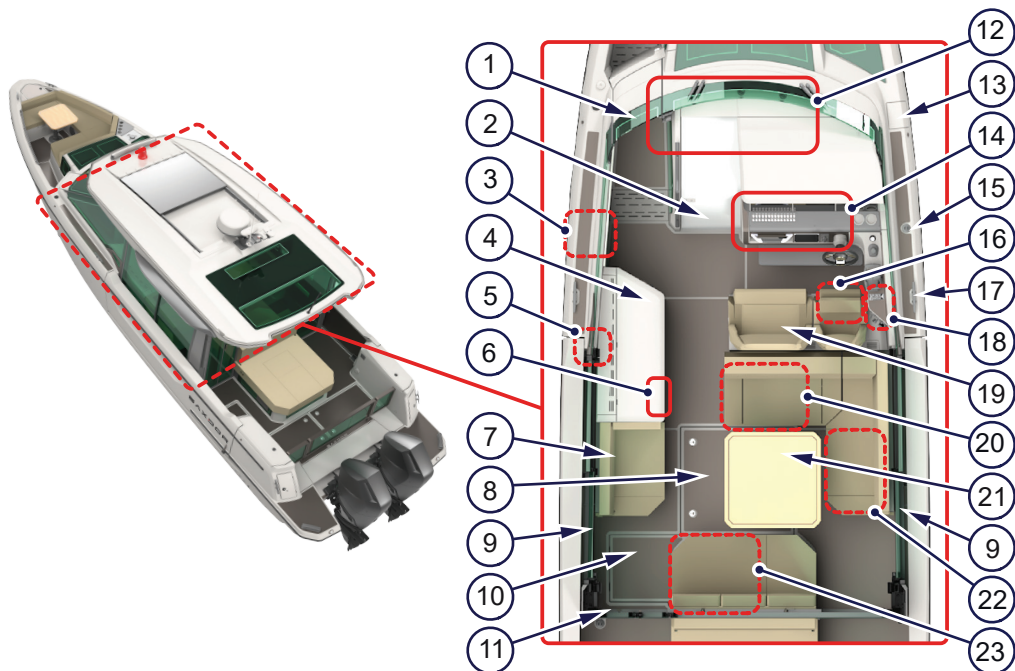

Figure 4.4 - Main cabin

- | | | | |
|----|--|----|--|
| 1 | Door and doorway to the foredeck | 13 | Toilet compartment ventilation opening |
| 2 | Door and doorway to the front cabin (Emergency exit) | 14 | Helm station |
| 3 | Access hatch to the fuel and water pipes | 15 | Black water discharge outlet |
| 4 | Wet bar | 16 | Battery control panel / Manual bilge pump |
| 5 | Access hatch to the electrical systems (behind the fridge) | 17 | Middle cleats |
| 6 | Sofa and table control panel | 18 | Access hatch to electrical connections |
| 7 | Wet bar seat and drawer | 19 | Driver's and passengers' seats |
| 8 | Access hatch to fuel tank and storage | 20 | Electric sofa |
| 9 | Door and doorway to the bathing platform | 21 | Electric table |
| 10 | Access hatch to the aft cabin | 22 | Sofa and storage |
| 11 | Door and doorway to the aft deck | 23 | Door and doorway to the aft cabin (Emergency exit) |
| 12 | Windshield and wipers | | |

4.1.4 Aft cabin

Check here the facilities and equipment that you can find in the aft cabin.

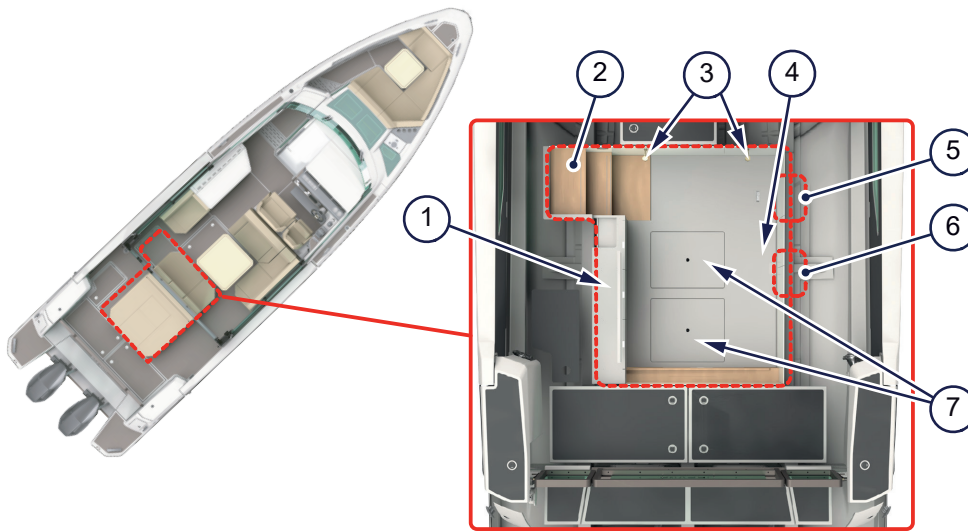

Figure 4.5 - Aft cabin

- | | | | |
|---|-------------------------|---|--|
| 1 | Locker | 5 | Recommended location for the smoke and CO detector |
| 2 | Stairs to the aft cabin | 6 | Heating and air conditioning outlets |
| 3 | Lights | 7 | Storage under the bed |
| 4 | Bed | | |

4.1.5 Aft deck

See here what you can find on the aft deck.

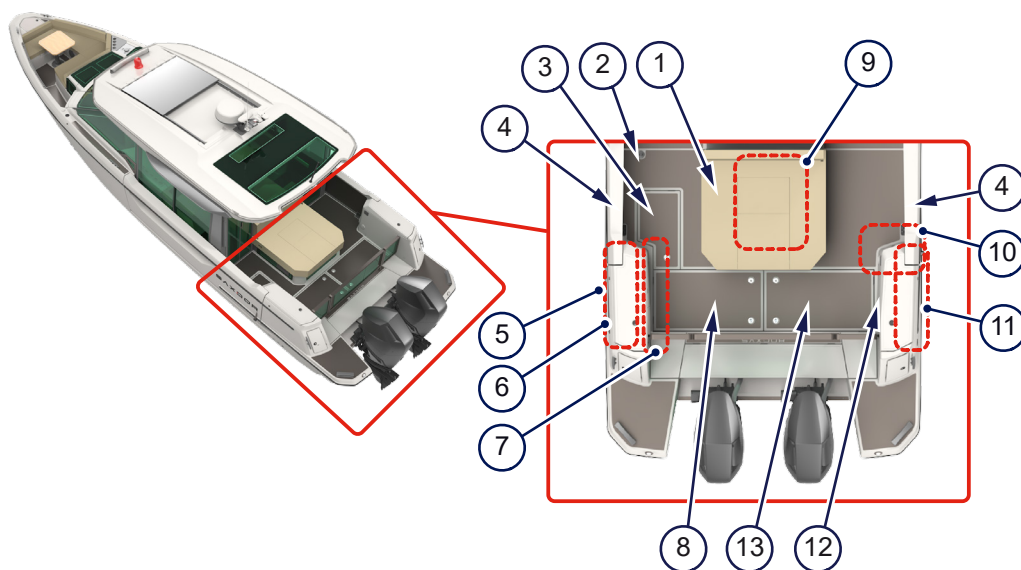

Figure 4.6 - Aft deck

- | | | | |
|---|---------------------------------|----|---|
| 1 | Sofa | 8 | Aft technical compartment (batteries) |
| 2 | Grey water discharge outlet | 9 | Emergency exit from the aft cabin |
| 3 | Storage / cooler box hatch | 10 | Side terrace control panel |
| 4 | Side terraces | 11 | Diesel fuel inlet and storage |
| 5 | Barbecue grill | 12 | Deck lights (both sides of the deck) |
| 6 | Fresh water tap and sink | 13 | Aft technical compartment (generator replacement system, batteries) |
| 7 | Access hatch to drainage valves | | |

4.1.6 Bathing platform

See here what you can find on the bathing platform.

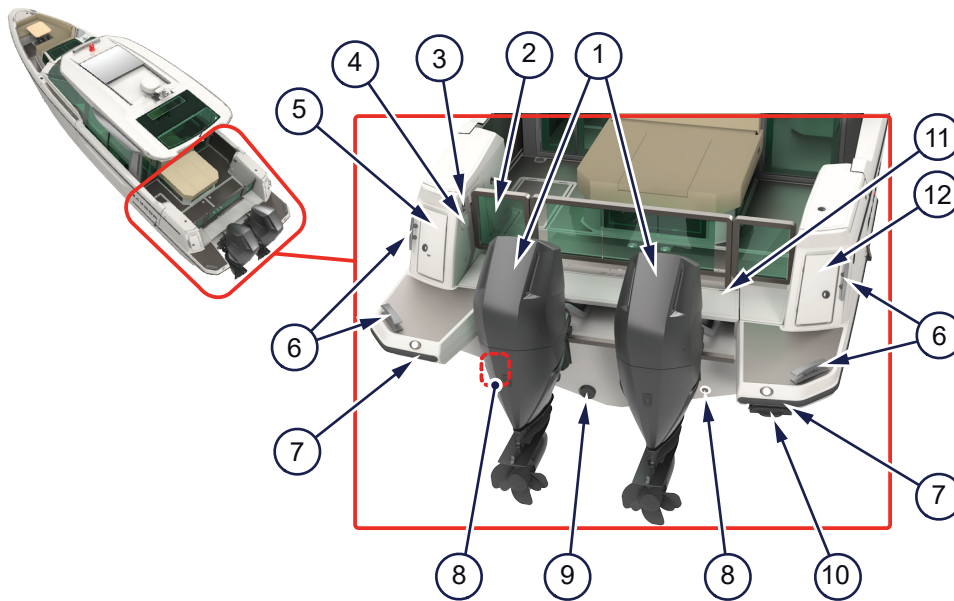

Figure 4.7 - Bathing platform

- | | | | |
|---|-----------------------------------|----|---------------------------------------|
| 1 | Twin engines | 7 | Warning lights for rotating propeller |
| 2 | Transom gates | 8 | Underwater lights |
| 3 | Fresh water control panel | 9 | Zinc anode |
| 4 | Fresh water shower | 10 | Bathing ladder |
| 5 | Shore power panel 1 | 11 | Engine well bridge |
| 6 | Aft cleats for towing and mooring | 12 | Shore power panel 2 |

4.2 User controls

See here the location of the different user controls on your boat.

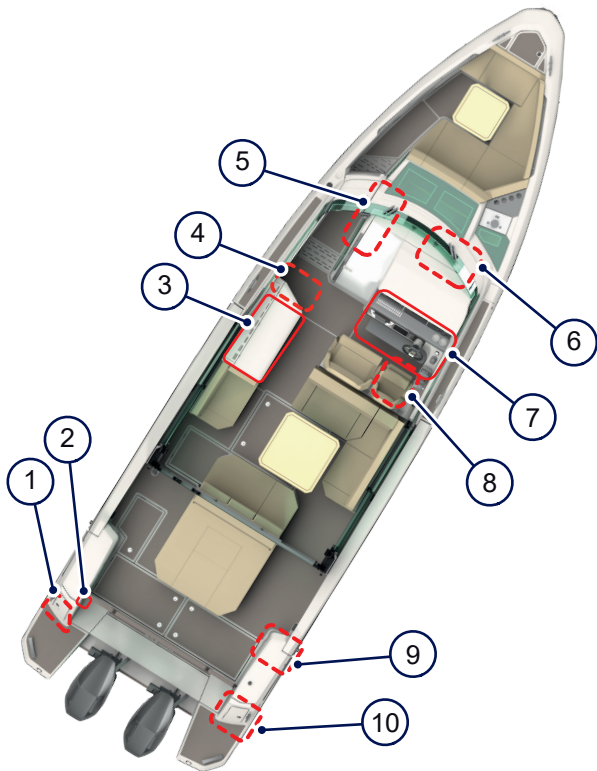

Figure 4.8 - Locations of user controls

- | | | | |
|---|---|----|----------------------------------|
| 1 | Shore power panel 1 | 6 | Toilet compartment control panel |
| 2 | Fresh water control panel | 7 | Helm station controls |
| 3 | Sofa and table control panel and cooktop control panel | 8 | Battery control panel |
| 4 | Temperature control panel for heating | 9 | Side terrace control panel |
| 5 | Fuse panel / Temperature control panel for air conditioning | 10 | Shore power panel 2 |

4.2.1 Helm station controls

Get a quick overview of the locations and names of different controls at the helm station. Drill deeper into the functions available for each control unit in the following sections.

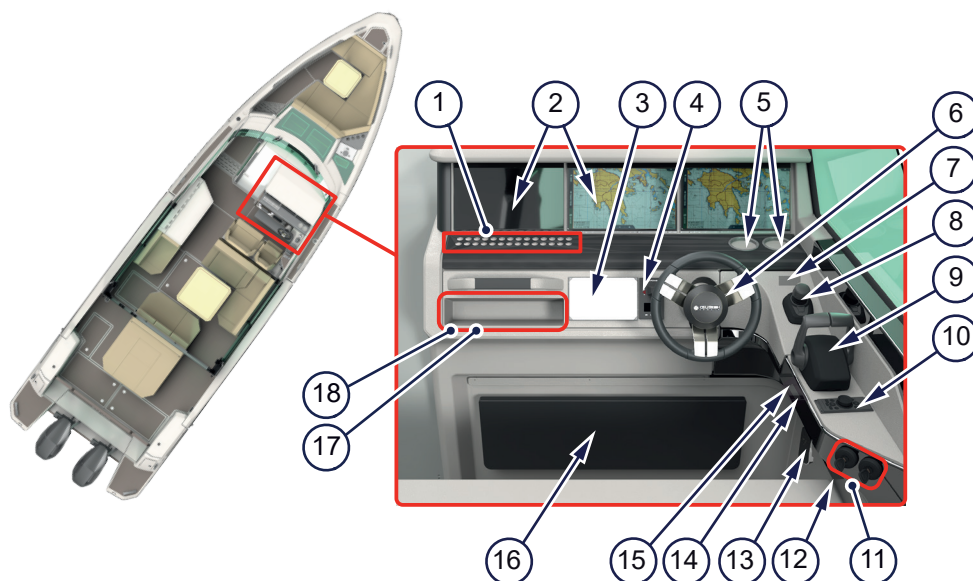

Figure 4.9 - Helm station controls

- | | | | |
|---|------------------------------------|----|---|
| 1 | Boat system and equipment controls | 10 | Remote control for multifunction displays |
| 2 | Main multifunction displays | 11 | Ignition key switch (1 and 2) |
| 3 | Battery charging system display | 12 | Lanyard stop switch |
| 4 | Bow thruster control panel | 13 | VHF and AIS handset |
| 5 | Cup holders | 14 | Mercury diagnostic port |
| 6 | Steering wheel | 15 | SD card reader |
| 7 | Audio control switch | 16 | Foot rest |
| 8 | Mercury piloting joystick | 17 | Glove compartment and VHF radio speaker |
| 9 | Engine throttle and shift control | 18 | Mobile phone charger and USB outlet |

Learn more

- How to use the engine controls, lanyard stop switch and how to trim your boat: [3.2 Driving and steering](#) on page 23

Related information

[5.2 Engine and steering system](#) on page 70

[5.6 Navigation equipment](#) on page 81

[5.7 Anchor system](#) on page 82

4.2.1.1 Navigation and lighting control panel

The navigation and lighting control panel controls navigation equipment, anchor, lights and bilge pumps.

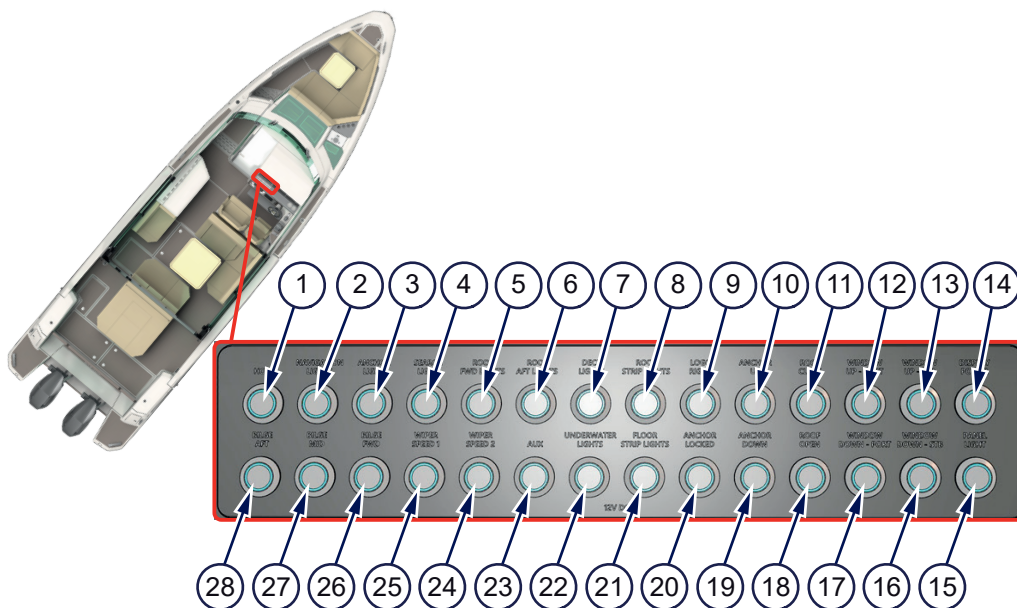

Figure 4.10 - Control functions on the navigation and lighting control panel

1	Horn	15	Panel light
2	Navigation lights	16	Starboard window down
3	Anchor light	17	Port window down
4	Search light	18	Roof open
5	Roof FWD lights	19	Anchor down
6	Roof AFT lights	20	Anchor locked
7	Deck lights	21	Floor strip lights
8	Roof strip lights	22	Underwater lights
9	Logo right	23	Auxiliary battery
10	Anchor up	24	Wiper speed 2
11	Roof close	25	Wiper speed 1
12	Port window up	26	Bilge pump FWD
13	Starboard window up	27	Bilge pump MID
14	Display power	28	Bilge pump AFT

Learn more

- When to use bilge pumps in case of flooding: [2.6.1 What if your boat is flooded?](#) on page 19
- Before departure checklist for navigation: [3.1 Get going!](#) on page 22

Related information

- [5.4 Draining system](#) on page 75
- [5.6 Navigation equipment](#) on page 81
- [5.8.8 Lighting and audio](#) on page 89

4.2.2 Sofa and table control panel

You can change the seating direction of the electric sofa, as well as lift and lower the electric table from the sofa and table control panel.

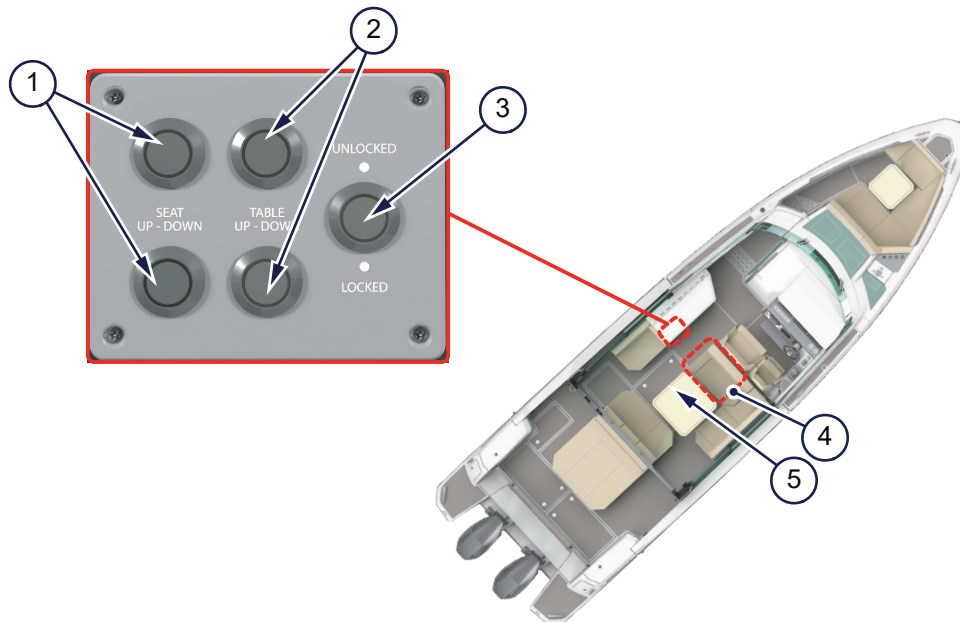

Figure 4.11 - Main cabin table control panel

- | | | | |
|---|---------------------------------|---|----------------|
| 1 | Electric sofa up / down | 4 | Electric sofa |
| 2 | Electric table up / down | 5 | Electric table |
| 3 | Lock release for sofa and table | | |

4.2.3 Toilet compartment control panel

You can operate the toilet as well as the fresh and waste water pumps from the toilet compartment control panel.

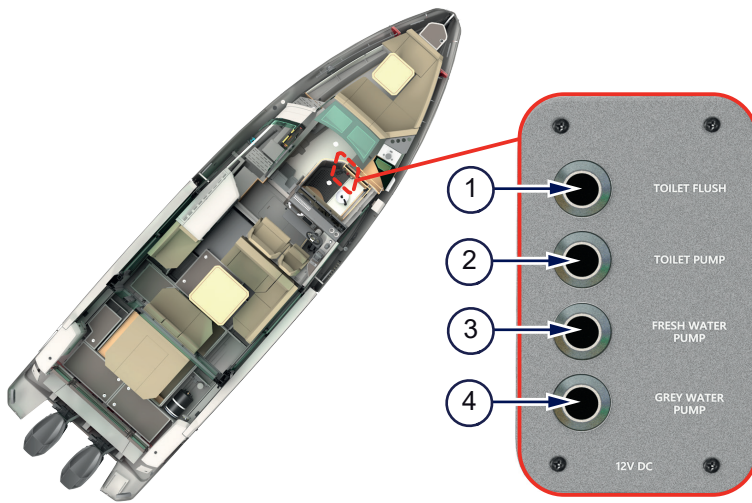

Figure 4.12 - Toilet compartment control panel

- | | | | |
|---|--------------|---|------------------|
| 1 | Toilet flush | 3 | Fresh water pump |
| 2 | Toilet pump | 4 | Grey water pump |

Related information

[5.5 Fresh and waste water systems](#) on page 77

4.2.4 High bilge alarm control panel

See here the location of the high bilge alarm control panel.

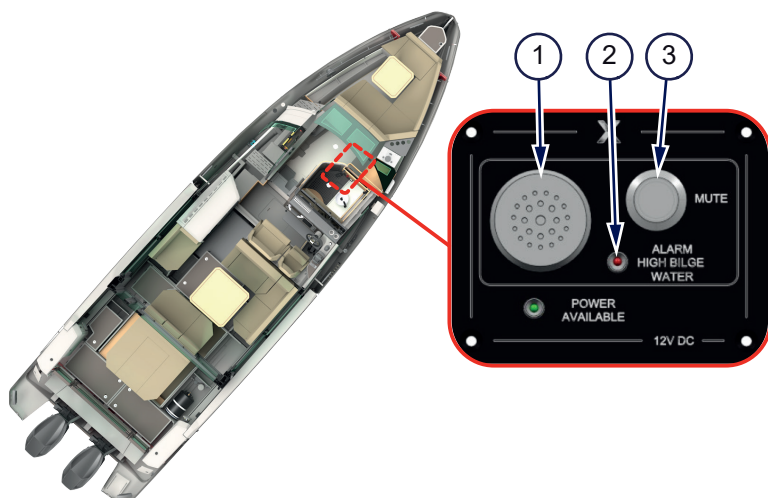

Figure 4.13 - High bilge alarm control panel

- | | | | |
|---|---------------|---|-------------|
| 1 | Buzzer | 3 | Mute button |
| 2 | Warning light | | |

4.2.5 Side terrace control panel

You can operate the side terraces from the side terrace control panel.

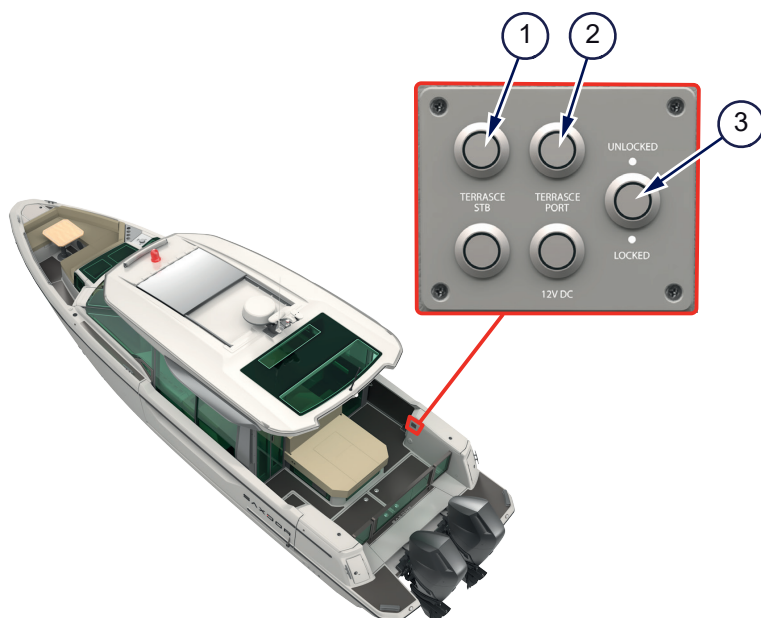

Figure 4.14 - Side terrace control panel

- | | | | |
|---|---------------------------|---|----------------------|
| 1 | Starboard terrace down/up | 3 | Terrace lock release |
| 2 | Port terrace down/up | | |

Related information

[5.8.4 Side terraces](#) on page 86

4.2.6 Fuse panel

The fuse panel contains the fuses, switches and indicators for the electrical equipment on your boat.

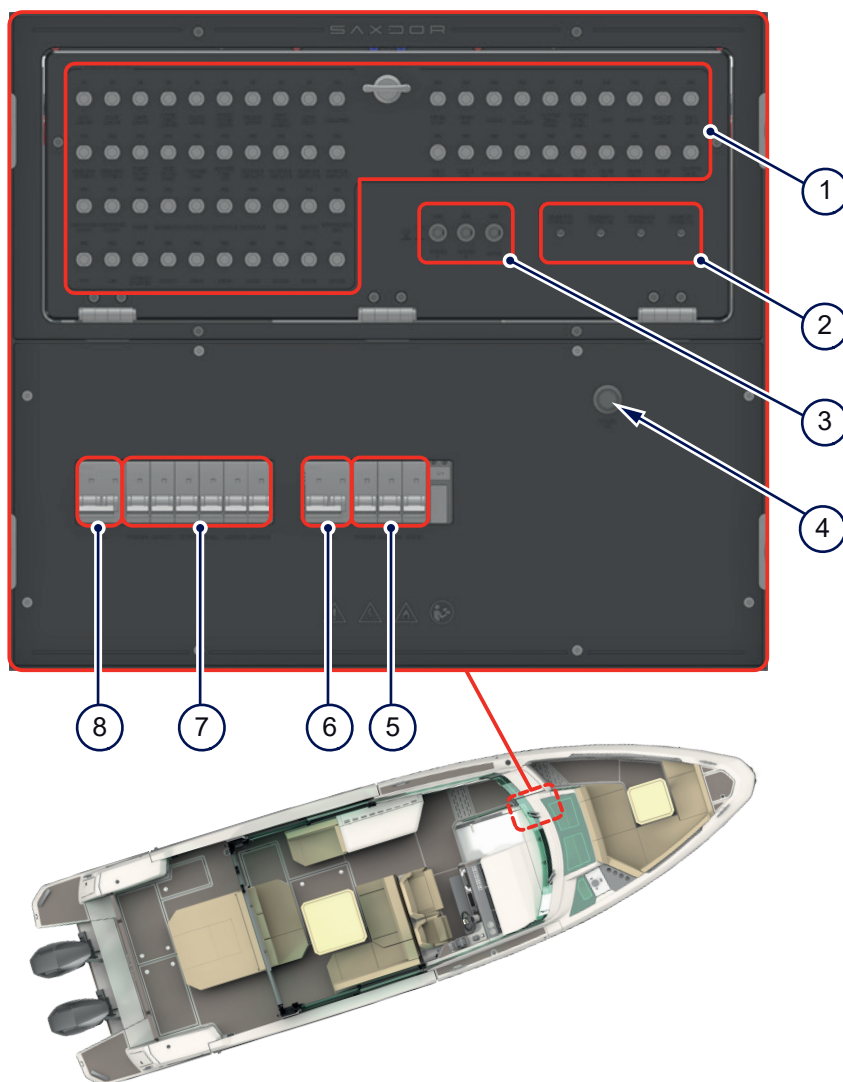

Figure 4.15 - Fuse panel

- | | | | |
|---|-----------------------------|---|--|
| 1 | Fuses 12 V | 5 | 110 V or 230 V fuses for shore power 2 |
| 2 | Bilge pump indicator lights | 6 | Shore power 2 main switch / overcurrent protection |
| 3 | Fridge and stove buttons | 7 | 110 V or 230 V fuses for shore power 1 |
| 4 | Water heater on/off | 8 | Shore power 1 main switch / overcurrent protection |

4.2.7 Battery control panel

Check here the location of your boat's battery control panel. The panel contains the battery on/off switches. You can use the battery on/off switches to turn power off from the batteries to the equipment on your boat when you leave the boat unattended, and turn power on when you return.

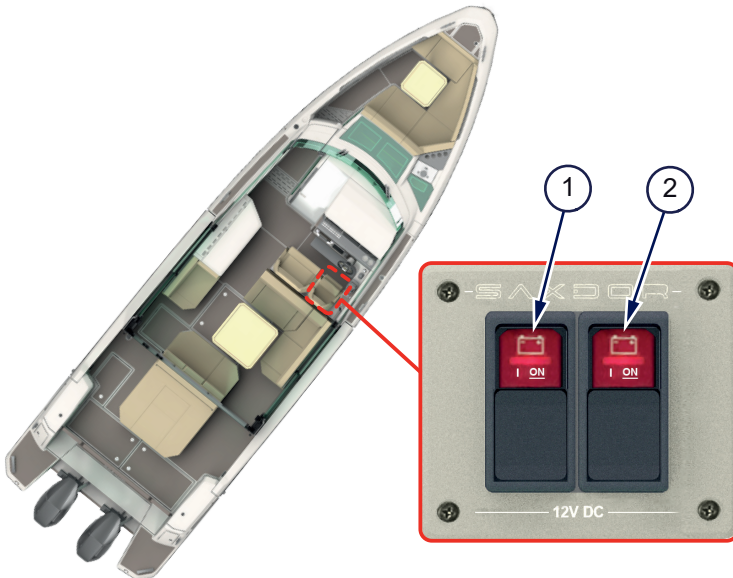

Figure 4.16 - Battery control panel

- 1 Switch for engine batteries and bow thruster batteries
- 2 Switch for house (auxiliary) batteries

Related information

[5.1 Electrical system](#) on page 60

4.2.8 Shore power panel

Check here the location of the port and starboard shore power panels to connect your boat to shore power.

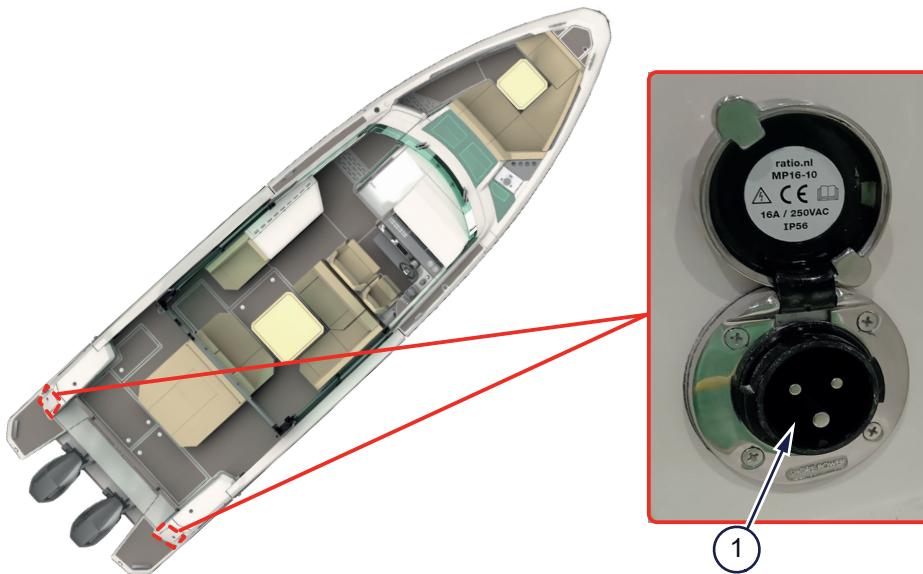

Figure 4.17 - Shore power panel

- 1 Shore power inlet

Related information

[5.1.4 Shore power](#) on page 66

4.2.9 Cooktop control panel

You can use the cooktop control panel to operate the optional diesel-powered cooktop on the wet bar.

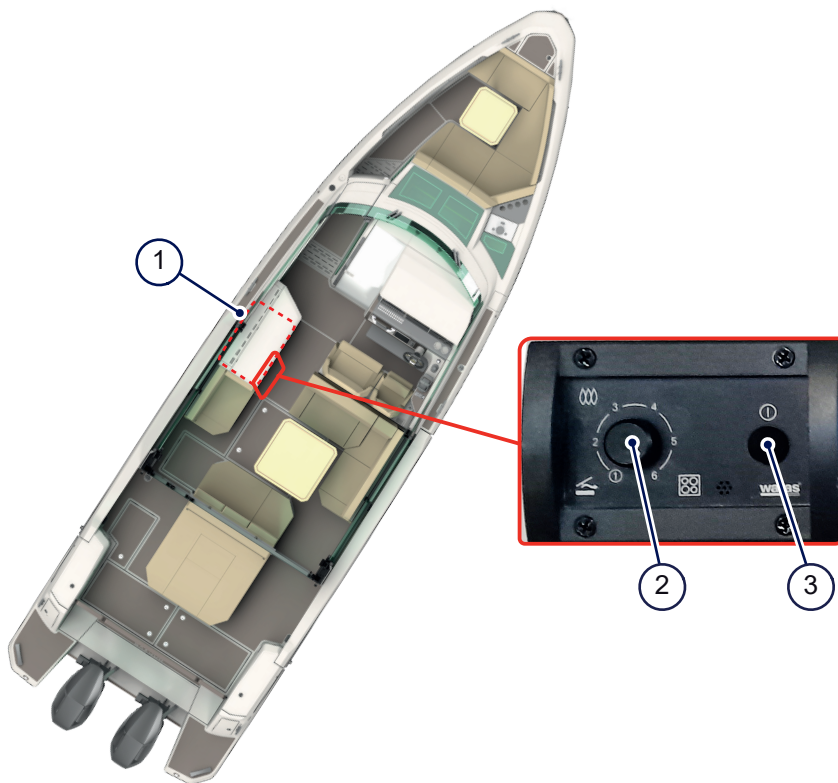

Figure 4.18 - Cooktop control panel

- | | | | |
|---|----------------------|---|----------------------|
| 1 | Cooktop | 3 | Cooktop power on/off |
| 2 | Cooktop heat setting | | |

Check the cooktop manufacturer's manual for more information on the features and the use of the equipment.

Related information

[5.8.2 Wet bar and barbecue grill](#) on page 84

4.2.10 Temperature control panel

Check here the location of your boat's temperature control panel.

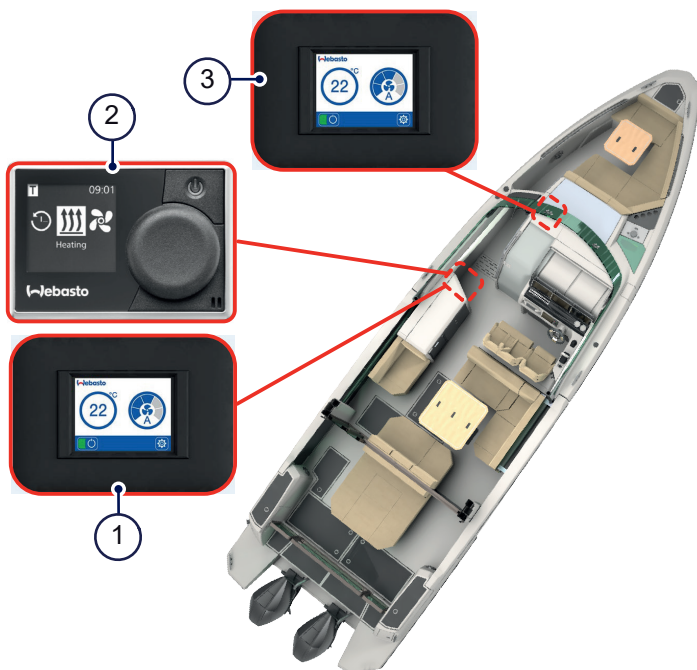

Figure 4.19 - Temperature control panel

- 1 Temperature control panel for main cabin air conditioning (optional)
- 2 Temperature control panel for heating
- 3 Temperature control panel for front cabin air conditioning

4.3 Builder's plate

Check here the location and details on the builder's plate on your boat.

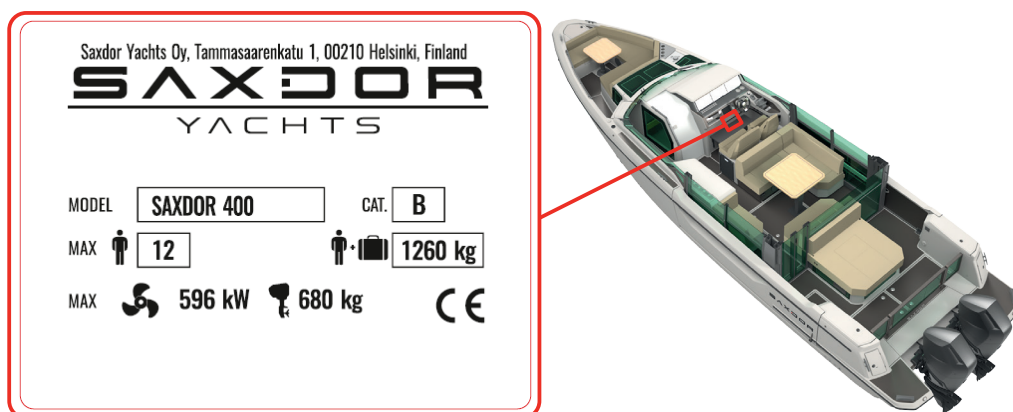

Figure 4.20 - Builder's plate



The maximum load indicated on the plate does not include the content of the tanks.

Learn more

- About the purpose of the builder's plate: [2.3 What is builder's plate?](#) on page 14

4.4 Hull identification number

Hull identification number (HIN) is a unique identifier for your boat and can be used to track your boat's history.

Contact your Saxdor dealer if you need to find out your boat's HIN or its location. Never remove or alter your boat's HIN.

4.5 Safety on board

Check here the basic safety features on your boat.

4.5.1 Safety equipment and emergency exits

Check here the location of your boat's safety equipment and emergency exits.

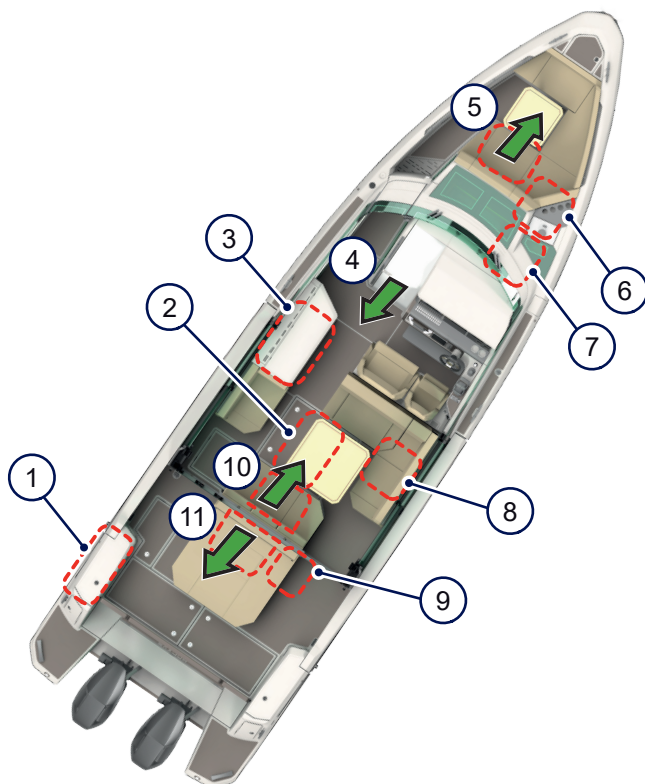

Figure 4.21 - Safety equipment and emergency exits

- | | | | |
|---|---|----|---|
| 1 | Recommended location for the fire extinguisher in the aft storage | 7 | Recommended location for the smoke and CO detector in the front cabin |
| 2 | Recommended location for the life raft | 8 | Recommended location for the fire extinguisher in the sofa storage |
| 3 | Recommended location for the fire blanket | 9 | Recommended location for the smoke and CO detector in the aft cabin |
| 4 | Emergency exit through the front cabin doorway | 10 | Emergency exit through the aft cabin doorway |
| 5 | Emergency exit through the foredeck hatch (under the foredeck sofa) | 11 | Emergency exit through the aft deck hatch (under the aft deck sofa) |
| 6 | Recommended location for the fire extinguisher in the wardrobe of the front cabin | | |

4.5.2 Safe seating and moving areas

See where passengers are allowed be seated and move about in different situations.

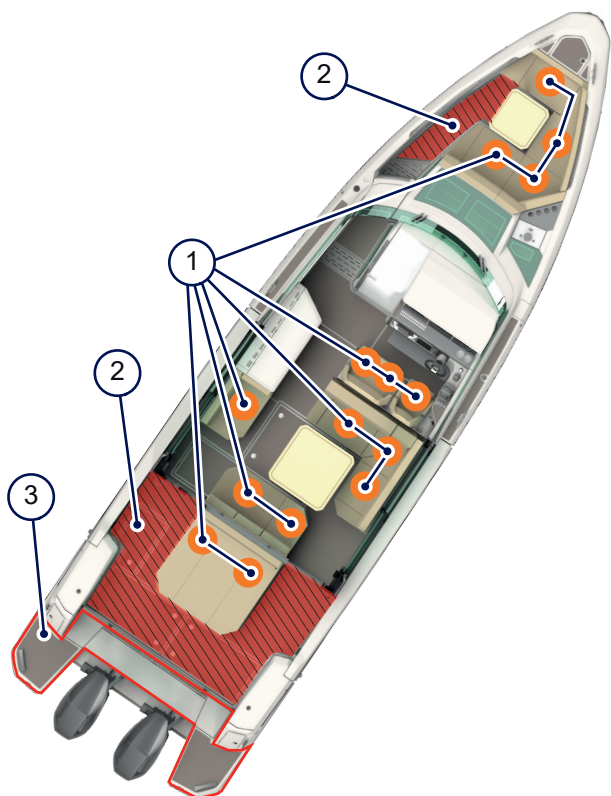

Figure 4.22 - Safe seating and moving areas

- | | | | |
|---|-------------------|---|--|
| 1 | Allowed seating | 3 | Deck area designed for anchoring, mooring and emergency operations, or use when the boat is stationary |
| 2 | Working deck area | | |

Learn more

- Limitations on the number of people on board: [2.4 What is design category?](#) on page 15
- Using the designated areas: [2.5.3 Move safely on board](#) on page 17
- How to recover people from the water: [2.6.3 Man overboard!](#) on page 20

4.5.3 Safety labels on board

The safety labels on your boat emphasize important safety precautions, which every crew member must pay attention to.

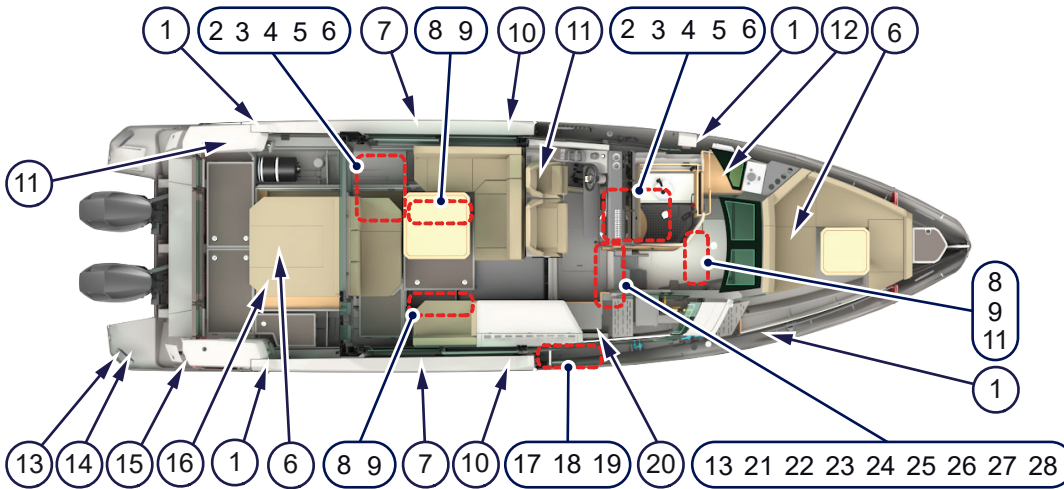

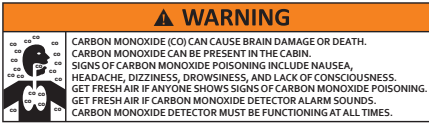
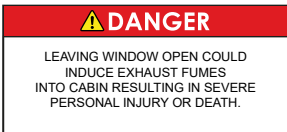
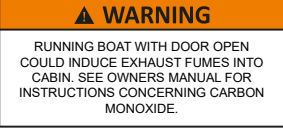



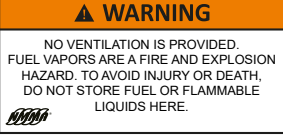



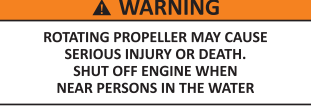
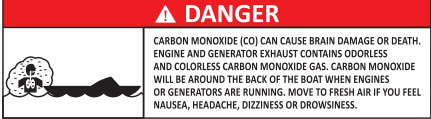

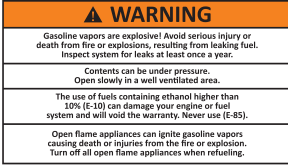





Figure 4.23 - Location of safety labels on your boat



Table 4.1 - Safety labels on board

Number	Label	Clarification
1		Indicates a lifting point.
2		WARNING Keep stairs and door shut while underway.
3		WARNING Carbon monoxide (CO) can cause brain damage or death. Carbon monoxide can be present in the cabin. Signs of carbon monoxide poisoning include nausea, headache, dizziness, drowsiness, and lack of consciousness. Get fresh air if anyone shows signs of carbon monoxide poisoning. Get fresh air if carbon monoxide detector alarm sounds. Carbon monoxide detector must be functioning at all times.
4		DANGER Leaving window open could induce exhaust fumes into cabin resulting in severe personal injury or death.

Number	Label	Clarification
5		<p>WARNING</p> <p>Running the boat when the door marked with the warning is open could induce exhaust fumes into cabin. See the owner's manual for instructions concerning carbon monoxide.</p>
6		<p>Indicates a designated emergency exit.</p>
7		<p>The maximum load allowed on the bathing platform is 300 kg (660 lb).</p>
8		<p>Indicates the location of a fire extinguisher.</p>
9		<p>WARNING</p> <p>No ventilation is provided. Fuel vapors are a fire and explosion hazard. To avoid injury or death, do not store fuel or flammable liquids here.</p>
10		<p>STOP AQUATIC HITCHHIKERS</p> <p>Recreational boating may spread aquatic invasive species. Clean off visible aquatic plants, animals, and mud from the boat, engine, trailer, and equipment before leaving water access. Drain the engine, bilge, and other water containing devices. Let everything dry for at least five days or wipe with a towel before reuse.</p>
11		<p>WARNING</p> <p>The water in the fresh water system is non-potable. Do not drink it.</p>
12		<p>Indicates a risk of head injury due to reduced headroom.</p>
13		<p>WARNING</p> <p>A rotating propeller may cause a serious injury or death. Shut off the engine when there are people in the water near the boat.</p>

Number	Label	Clarification
14		<p>DANGER</p> <p>Carbon monoxide (CO) can cause brain damage or death. Engine and generator exhaust contains odorless and colorless carbon monoxide gas. Carbon monoxide will be around the back of the boat when engines or generators are running. Move to fresh air if you feel nausea, headache, dizziness or drowsiness.</p>
15		<p>WARNING</p> <p>Electrical shock and fire hazard. Failure to follow these instructions may result in injury or death.</p> <ol style="list-style-type: none"> 1. Turn off the boat's shore power connection switch before connecting or disconnecting the shore power cable. 2. Connect the shore power cable at the boat first. 3. If the polarity-warning indicator is activated, immediately disconnect the cables. 4. Disconnect the shore power cable at the shore outlet first. 5. Close the shore power inlet cover tightly. <p>Do not alter the shore power cable connectors.</p>
16		<p>WARNING</p> <p>Keep the door shut when the boat is moving.</p>
17		<p>WARNING</p> <p>Gasoline vapors are explosive! Avoid serious injury or death from fire or explosions, resulting from leaking fuel. Inspect the system for leaks at least once a year.</p> <p>The contents can be under pressure. Open slowly in a well ventilated area.</p> <p>The use of fuels containing ethanol higher than 10% (E-10) can damage your engine or fuel system and will void the warranty. Never use (E-85).</p> <p>Open flame appliances can ignite gasoline vapors, causing death or injuries from fire or explosion. Turn off all open flame appliances when refueling.</p>
18		<p>WARNING</p> <p>Gasoline vapours may cause fires or explosions. Do not overfill the fuel tank. Keep the boat away from flames and sparks. Do not start the engine if liquid gasoline or vapours are present. Always replace the engine cover (or seat) before starting.</p>
19		<p>WARNING</p> <p>Leaking fuel can cause fire or explosion which may lead to serious injury or death.</p>

Number	Label	Clarification
20	<p>▲ WARNING</p> <p>Before activating Skyhook: 1. Check that no one is in the water. 2. Tell passengers not to enter water. Skyhook makes the propellers spin. This can injure swimmers.</p> <p style="text-align: right; font-size: small;">8M0034159</p>	<p>WARNING</p> <p>Swimmers can be injured by the spinning propellers when Skyhook is activated.</p> <p>Before activating Skyhook, check that no one is in the water and tell the passengers not to enter water.</p>
21	<p>▲ WARNING</p>  <p>CARBON MONOXIDE (CO) CAN CAUSE BRAIN DAMAGE OR DEATH. ENGINE AND GENERATOR EXHAUST CONTAINS ODORLESS AND COLORLESS CARBON MONOXIDE GAS. SIGNS OF CARBON MONOXIDE POISONING INCLUDE NAUSEA, HEADACHE, DIZZINESS, DROWSINESS, AND LACK OF CONSCIOUSNESS. GET FRESH AIR IF ANYONE SHOWS SIGNS OF CARBON MONOXIDE POISONING. SEE OWNER'S MANUAL FOR INFORMATION REGARDING CARBON MONOXIDE POISONING.</p>	<p>WARNING</p> <p>Carbon monoxide (CO) can cause brain damage or death. Engine and generator exhaust contains odorless and colorless carbon monoxide gas. Signs of carbon monoxide poisoning include nausea, headache, dizziness, drowsiness, and lack of consciousness. Get fresh air if anyone shows signs of carbon monoxide poisoning. See the owner's manual for information regarding carbon monoxide poisoning.</p>
22	<p>▲ WARNING</p> <p>ATTACH SHUT DOWN SWITCH LANYARD TO QUALIFIED OPERATOR WHILE ENGINE IS IN OPERATION. UNCONTROLLED BOAT MAY CAUSE INJURY OR DEATH. READ OWNERS MANUAL BEFORE USE.</p>	<p>WARNING</p> <p>Attach the shut down switch lanyard to a qualified operator while the engine is in operation. An uncontrolled boat may cause injury or death. Read the owner's manual before use.</p>
23	<p>▲ WARNING</p> <p>QUALIFIED OPERATOR TO BE IN CONTROL AT ALL TIMES. OPERATION BY AN UNQUALIFIED OPERATOR CAN CAUSE LOSS OF CONTROL. THIS MAY RESULT IN SEVERE INJURY, DEATH OR PROPERTY DAMAGE. BOAT STABILITY AND HANDLING WILL CHANGE WITH WEIGHT DISTRIBUTION. READ OWNERS MANUAL BEFORE USE.</p>	<p>WARNING</p> <p>A qualified operator must be in control at all times. Operation by an unqualified operator can cause loss of control. This may result in severe injury, death or property damage. Boat stability and handling will change with weight distribution. Read the owner's manual before use.</p>
24	<p>▲ WARNING</p> <p>USE CAUTION WITH SKIER IN TOW AS TOW ROPE MAY BACKSPASH INTO COCKPIT WHEN RELEASED.</p>	<p>WARNING</p> <p>Use caution when a skier is in tow as the tow rope may backlash into the cockpit when released.</p>
25	<p>BOATMAN'S CHECK LIST</p> <p>For maximum enjoyment and safety, check each of these items BEFORE you start your engine:</p> <ul style="list-style-type: none"> ✓DRAIN PLUG (Securely in place?) ✓LIFE-SAVING DEVICES (One for each person on board?) ✓STEERING SYSTEM (Working smoothly and properly?) ✓FUEL SYSTEM (Adequate fuel? Leaks? Fumes?) ✓BATTERY (Fully charged? Cable terminals clean and tight?) ✓ENGINE (In neutral?) ✓CAPACITY PLATE (Are you overloaded or overpowered?) ✓WEATHER CONDITIONS (Safe to go out?) ✓ELECTRICAL EQUIPMENT (Lights, horn, pump, etc.?) ✓EMERGENCY GEAR (Fire extinguisher, bailer, paddle, anchor & line, signaling device, tool kit, etc.?)  <p style="text-align: right; font-size: small;">© NMMMA 1981</p>	<p>BOATMAN'S CHECKLIST</p> <p>For maximum safety and enjoyment, check each of the items listed on the label BEFORE you start your engine:</p> <ul style="list-style-type: none"> • DRAIN PLUGS (Securely in place?) • LIFE-SAVING DEVICES (One for every person on board?) • STEERING SYSTEM (Working smoothly and properly?) • FUEL SYSTEM (Adequate fuel? Leaks? Fumes?) • BATTERY (Fully charged? Cable terminals clean and tight?) • ENGINE (In neutral?) • CAPACITY PLATE (Are you overloaded or overpowered?) • WEATHER CONDITIONS (Safe to go out?) • ELECTRICAL EQUIPMENT (Lights, horn, pump, etc. work OK?) • EMERGENCY GEAR (Fire extinguisher, bailer, paddle, anchor & line, signaling device, tool kit, etc. OK and available on board?)

Number	Label	Clarification
26	<p>DISCHARGE OF OIL PROHIBITED</p> <p>THE FEDERAL WATER POLLUTION CONTROL ACT PROHIBITS THE DISCHARGE OF OIL OR OILY WASTE INTO OR UPON THE NAVIGABLE WATERS OF THE UNITED STATES, OR THE WATERS OF THE CONTIGUOUS ZONE, OR WHICH MAY AFFECT NATURAL RESOURCES BELONGING TO, APPERTAINING TO, OR UNDER THE EXCLUSIVE MANAGEMENT AUTHORITY OF THE UNITED STATES, IF SUCH DISCHARGE CAUSES A FILM OR DISCOLORATION OF THE SURFACE OF THE WATER OR CAUSES A SLUDGE OR EMULSION BENEATH THE SURFACE OF THE WATER. VIOLATORS ARE SUBJECT TO SUBSTANTIAL CIVIL PENALTIES AND/OR CRIMINAL SANCTIONS INCLUDING FINES AND IMPRISONMENT.</p> 	<p>DISCHARGE OF OIL PROHIBITED</p> <p>The Federal Water Pollution Control Act prohibits the discharge of oil or oily waste upon or into any navigable waters of the United States, or the waters of the contiguous zone, or which may affect natural resources belonging to, appertaining to, or under the exclusive management authority of the United States, if such discharge causes a film or discoloration of the surface of the water or causes a sludge or emulsion beneath the surface of the water. Violators are subject to substantial civil penalties and/or criminal sanctions including fines and imprisonment.</p>
27	<p>▲ WARNING</p> <p>Death or serious injury can result if you fail to observe these safety rules:</p> <ul style="list-style-type: none"> • Anyone who controls the boat should have taken a boating safety course and have trained in the proper operation of the boat. • Always operate the boat at speeds that will not put people or property in danger. • Be constantly aware of conditions in all directions when underway and before turning. • Reduce speed, use a lookout to identify possible hazards or difficulties, and turn on navigation lights when: <ul style="list-style-type: none"> - visibility is impaired; - in rough water; and - in congested waterways. • Watch your wake. It can capsize a small boat or damage moored boats or other property. You are responsible for damage caused by your wake. 	<p>WARNING</p> <p>Death or serious injury can result if you fail to observe these safety rules:</p> <ul style="list-style-type: none"> • Anyone who controls the boat should have taken a boating safety course and have trained in the proper operation of the boat. • Always operate the boat at speeds that will not put people or property in danger. • Be constantly aware of conditions in all directions when underway and before turning. • Reduce speed, use a lookout to identify possible hazards or difficulties, and turn on navigation lights when: <ul style="list-style-type: none"> ◦ visibility is impaired; ◦ in rough water; and ◦ in congested waterways. • Watch your wake. It can capsize a small boat or damage moored boats or other property. You are responsible for damage caused by your wake.
28		<p>Label calling attention to reading the manual and paying attention to the warning labels.</p>

Check the equipment manufacturers' manuals for more information about safety precautions. Contact you Saxdor dealer if you need replacement safety labels.

4.6 Hull and deck

See here the features and equipment on the hull and deck.

4.6.1 Attachment points

Your boat is equipped with cleats for mooring, towing and attaching the boat onto a trailer. You can also use removable fender cleats that allow you to hang fenders to protect the hull when docking.

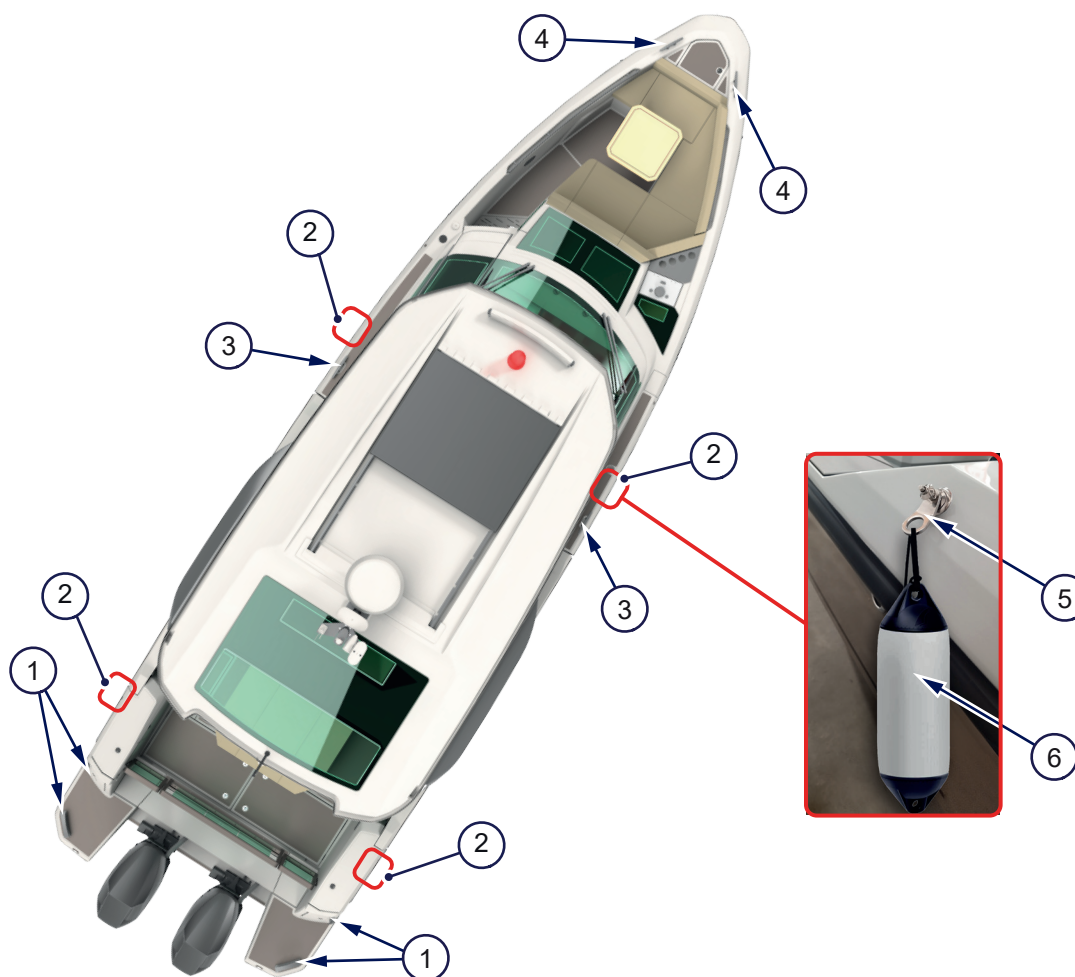

Figure 4.24 - Attachment points

- | | | | |
|---|------------------------|---|--------------|
| 1 | Aft cleats | 4 | Bow cleats |
| 2 | Fender cleat mountings | 5 | Fender cleat |
| 3 | Middle cleats | 6 | Fender |

CAUTION

Risk of injury to people, risk of damage to your boat or other vessels.

The protruding fender cleats may collide with people or other boats when driving.

Remove the fender cleats before you drive.

Learn more

- About how to use the cleats and fenders: [3.3 Mooring, towing and anchoring](#) on page 26

4.6.2 Lifting points

Check here the approximate locations for the lifting points of your boat as measured from the end of the keel in the aft of the boat.

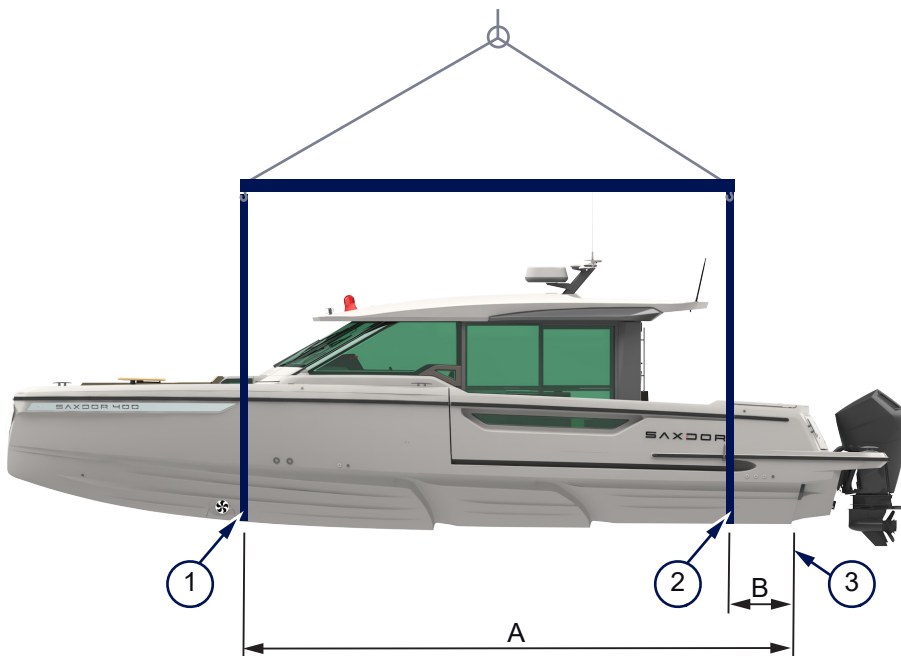

Figure 4.25 - Lifting points

- 1 Lifting point in the bow
- 2 Lifting point in the aft
- 3 Measuring point in the end of the keel

Table 4.2 - Lifting point locations

Dimension	Description	Value	
A	Minimum distance from the measuring point in the end of the keel to the lifting point in the bow	7.60 m	24.9 ft
B	Minimum distance from the measuring point in the end of the keel to the lifting point in the aft	0.80 m	2.6 ft

Learn more

- How to lift your boat: [3.4 Lifting and trailering](#) on page 27

4.6.3 Hull openings

Your boat has a number of openings through the hull. Check here their locations.

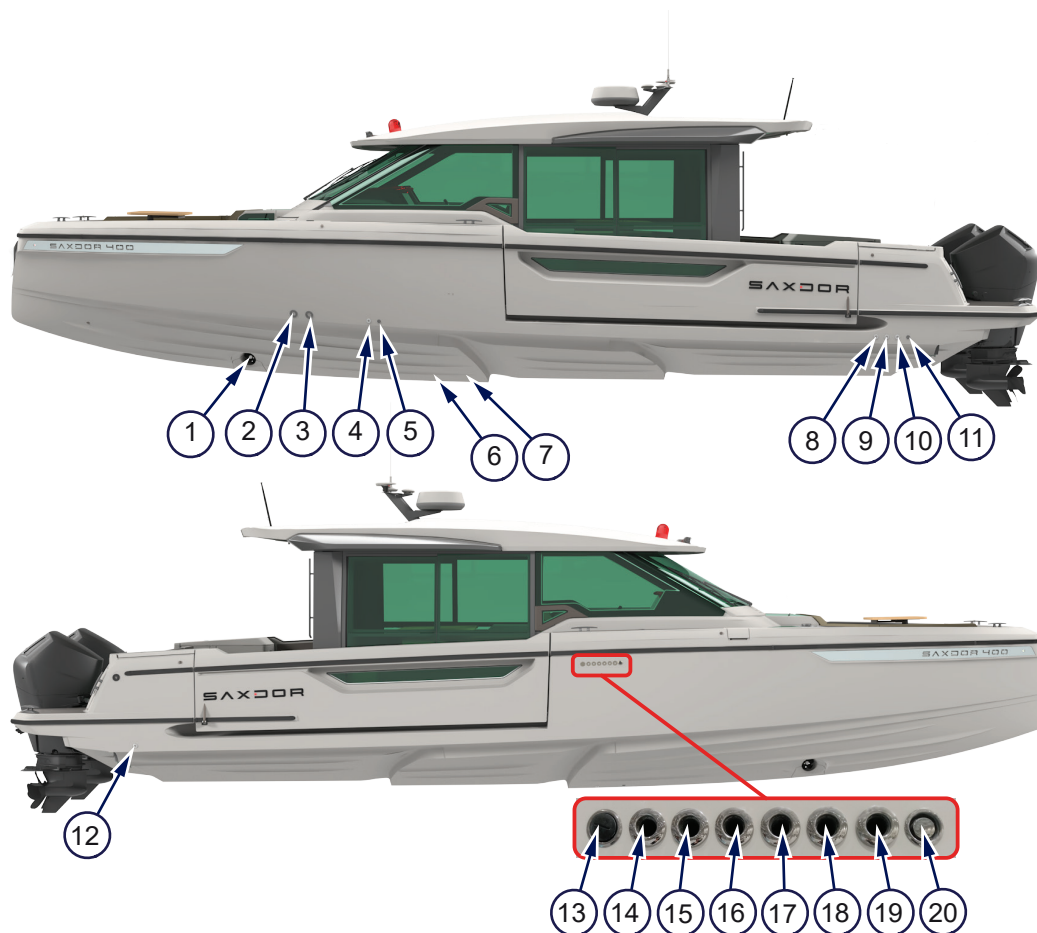

Figure 4.26 - Hull openings

- | | | | |
|----|----------------------------------|----|--|
| 1 | Bow thruster | 11 | Grey water tank seacock opening (option) |
| 2 | Deck draining seacock opening | 12 | Heater vent |
| 3 | Deck draining seacock opening | 13 | Fuel tank vent |
| 4 | Deck draining seacock opening | 14 | Bilge pump draining opening |
| 5 | Grey water seacock opening | 15 | Bilge pump draining opening |
| 6 | Air conditioner sea water intake | 16 | Bilge pump draining opening |
| 7 | Black water seacock opening | 17 | Bilge pump draining opening |
| 8 | Deck draining seacock opening | 18 | Bilge pump draining opening |
| 9 | Deck draining seacock opening | 19 | Manual bilge pump draining opening |
| 10 | Grey water seacock opening | 20 | Black water tank vent |

4.6.4 Hatches

The hatches provide you access to the cabins, the equipment and systems on your boat. Some of them also act as storage space and emergency exits.

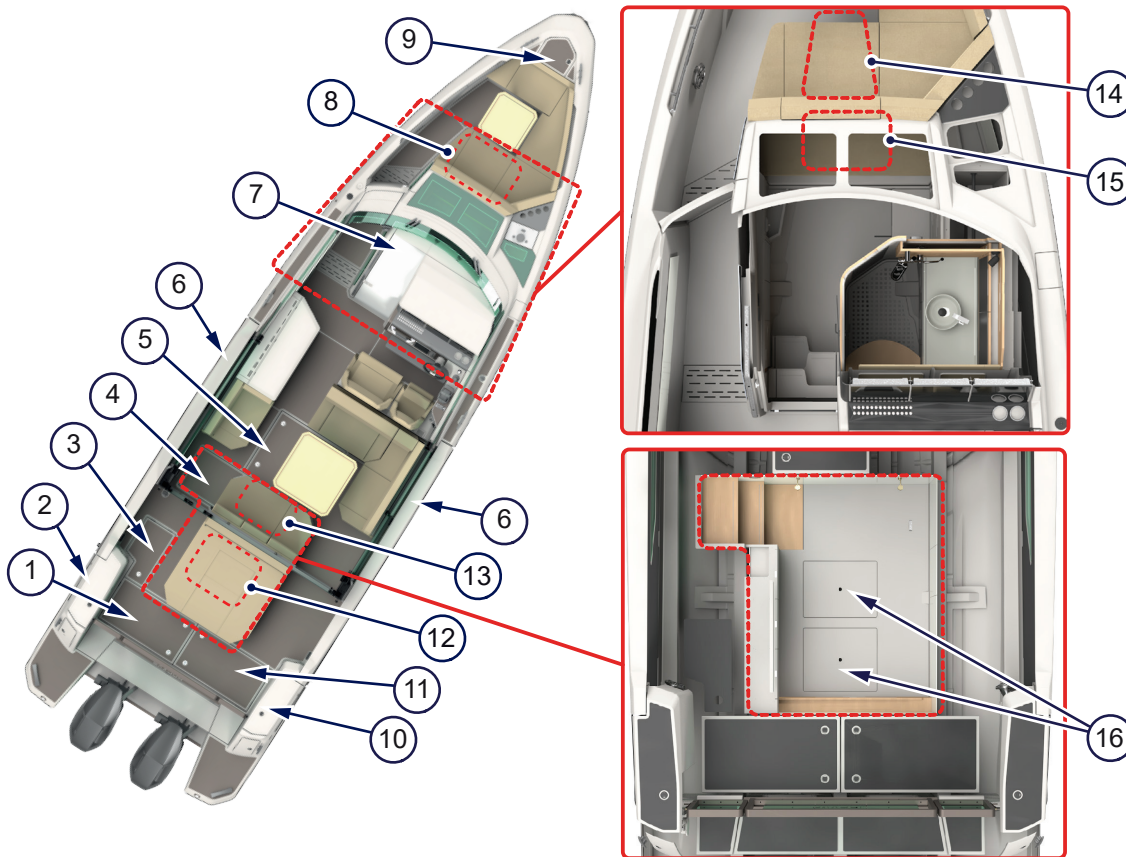

Figure 4.27 - Hatches

- | | | | |
|---|--|----|---|
| 1 | Aft technical compartment (batteries) | 9 | Anchor box hatch |
| 2 | Hatch to water tap, sink and barbecue grill | 10 | Hatch for the diesel fuel inlet |
| 3 | Storage / cooler box hatch | 11 | Aft technical compartment (generator replacement system, batteries) |
| 4 | Access hatch to the aft cabin | 12 | Emergency exit from the aft cabin |
| 5 | Technical hatch (fuel tank access and storage) | 13 | Aft cabin door and doorway (emergency exit) |
| 6 | Side terraces | 14 | Storage hatch in the front cabin |
| 7 | Front cabin door and doorway (emergency exit) | 15 | Front cabin technical compartment (bow thruster and anchor winch battery) |
| 8 | Emergency exit from the front cabin | 16 | Storage hatches in the aft cabin |

Related information

- [4.5.1 Safety equipment and emergency exits](#) on page 48
- [5.1 Electrical system](#) on page 60
- [5.7 Anchor system](#) on page 82
- [5.8.6 Bathing ladder](#) on page 88

4.6.5 Seacocks

Your boat has multiple seacocks. Check here their locations.

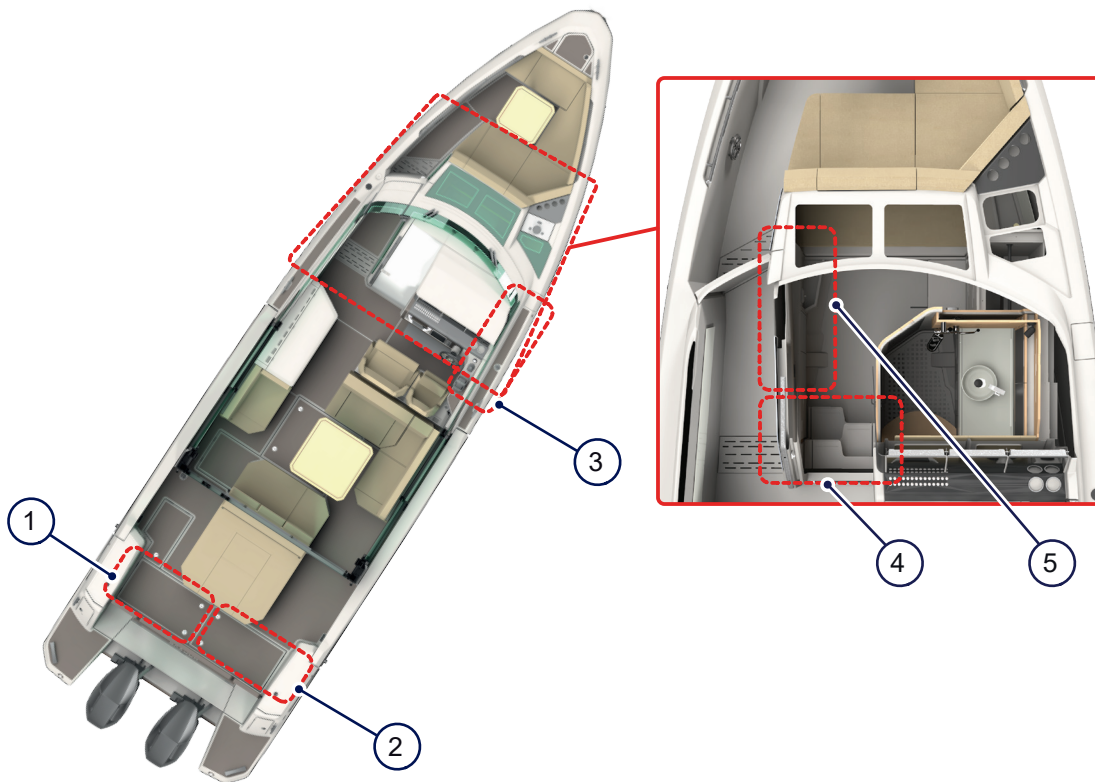

Figure 4.28 - Seacocks

- | | | | |
|---|----------------------------|---|--|
| 1 | Port side aft seacocks | 4 | Starboard optional aircon seacock, aircon system seacock and black water seacock |
| 2 | Starboard drainage seacock | 5 | Port side seacocks |
| 3 | Starboard side openings | | |

5 The how of your boat

Learn here how the different systems on your boat work and how to use them.

If you need more detailed, step-by-step instructions in using the equipment, refer to the equipment manufacturer's manuals provided in the Saxdor documentation bag.

5.1 Electrical system

The electrical system of your boat consists of a state-of-the-art power package which covers your power needs onshore and offshore.

⚠ DANGER

Risk of electric shock, fire or explosion.

Remember that water and electricity are a bad combination.

Let only a competent marine electrical technician carry out any installation, alteration or maintenance work to the electrical system.

⚠ WARNING

Risk of death, electric shock or injury.

Working on the electrical installation while the system is energized can cause an electric shock.

Never work on the electrical installation while the system is energized.

⚠ WARNING

Risk of electric shock or damage to the equipment.

Never alter or modify the rated current amperage of overcurrent protective devices.

The power package is a combination of batteries, shore power and the components of the generator replacement system. The NMEA network connects the different components of your power package. You can monitor the operation of the power package with an application on the multifunction display in the cockpit.



The less you use the electrical equipment on your boat, the longer the system can give you power.

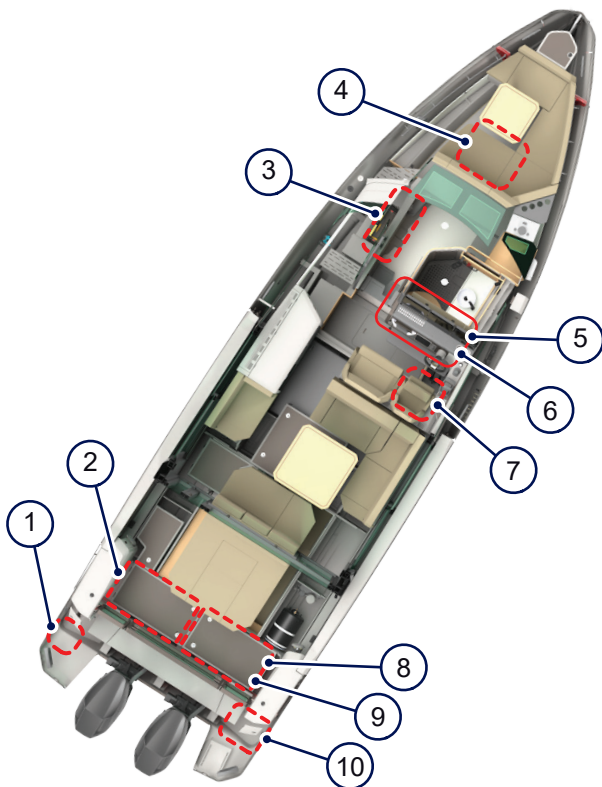

Figure 5.1 - Electrical system

- | | | | |
|---|---------------------------------------|----|---|
| 1 | Shore power panel 1 | 6 | Application on the multifunction display |
| 2 | Auxiliary batteries | 7 | Battery control panel |
| 3 | Fuse panel | 8 | Generator replacement system and engine batteries |
| 4 | Bow thruster and anchor winch battery | 9 | Service battery |
| 5 | Battery charging system display | 10 | Shore power panel 2 |

Related information

[4.2.6 Fuse panel](#) on page 42

[4.2.7 Battery control panel](#) on page 43

5.1.1 Main switches and indicators

The front cabin fuse panel contains main switches and indicators for the equipment on your boat.

The shore power main switch needs to be off when connecting to shore power. In addition, the main switch protects the boat from an overcurrent fault and a ground fault.



The Smart Battery Hub powers up only the priority equipment. Other equipment get the power from their dedicated batteries.

Related information

[4.2.6 Fuse panel](#) on page 42

5.1.1.1 Switching power on and off

To save battery power and for safety reasons, always switch the power off when you leave your boat unattended and switch the power on when you return.

CAUTION

Risk of electric shock.

Do not touch the batteries or electric connections.



To keep the boat afloat and for safety reasons, the priority equipment (bilge pump, fire protection and alarm equipment) keep on operating even when you switch the power off.



- When you leave the boat, use the on/off switches on the battery control panel to switch off power supply from the batteries to the equipment on your boat.
- When you return to the boat, use the on/off switches on the battery control panel to switch on the power supply.

Related information

[4.2.7 Battery control panel](#) on page 43

5.1.2 Fuses

The front cabin fuse panel on your boat contains separate fuses for the 12 V battery power and for the 110 V or 230 V shore power.

NOTICE

Risk of short circuit, overcurrent and damage to the equipment.

Make sure the amperage of the connected appliances does not exceed the amperage marked on the fuse.

Make sure the equipment and appliances on your boat are intact and properly connected.

- The 12 V fuses are connected to the different equipment and functions on your boat, such as lights, side terraces, radar, autopilot and water pumps.
- The main supply fuses are connected to the fridges and batteries.
- The priority fuses are connected to the priority equipment: bilge pump, fire protection and navigation lights. These systems require constant power supply. The systems stay on even when you switch off

the power supply to the other equipment from the battery control panel when you leave the boat unattended.



The smoke detector and the carbon monoxide detector have their own batteries as a backup in case of a power failure.

- DSF1#1 is the direct supply fuse, MSF1#1 the main supply fuse and MF1#1 the service main fuse.
- The shore power 110 V or 230 V fuses are connected to the battery charger, inverter, power outlets, electrical cooktop and air-conditioner unit. In addition, the shore power fuses protect these devices from an overcurrent fault.

Related information

[4.2.6 Fuse panel](#) on page 42

[4.2.7 Battery control panel](#) on page 43

5.1.2.1 Resetting tripped fuses

There are two types of fuses on your boat. Each type indicates the tripping differently and need to be reset differently.

When a 12 V DC fuse is tripped:

- The fuse button is up

When a 110 V / 230 V AC fuse is tripped:

- The switch in the fuse is down
- The indicator in the fuse is green

CAUTION

Risk of electric shock or damage to the equipment.

Before you reset the fuse, find out why it has tripped.



1. Reset the fuse:
 - Press the button of the 12 V DC fuse down.
 - Flip the switch of the 110 V / 230 V AC fuse up. The indicator in the fuse turns red.
2. Check that the equipment or appliances connected to the fuse work properly. If the problem persists, contact a qualified nautical electrician.

Related information

[4.2.6 Fuse panel](#) on page 42

5.1.3 Batteries

The batteries give your boat 12 V DC power when used offshore.

⚠ WARNING

Risk of electric shock, battery overheating, explosion, fire or harmful gases.

Do not block the battery ventilation.



You can monitor the power use and the battery capacity from an application on the multifunction display on the helm station.

There are several batteries on your boat, depending on the level of equipment you have chosen.

In the aft technical compartment:

- Two engine batteries power up the engines on your boat. Each engine has its own battery.
- The domestic service (house) batteries power up the other equipment on your boat.
- The battery pack of the optional generator replacement system can include two to four batteries, depending on your options.

In the cabin technical compartment (under the bed in the front cabin):

- The auxiliary battery powers up the bow thruster and the anchor winch.

Check the battery manufacturer's manual for more details/information about the batteries and their maintenance.

The battery hub manages the batteries. If the domestic batteries are empty, you can use the start batteries as a backup by switching their parallel switches ON in the battery hub.

The emergency parallel switches for the start batteries can be used in an emergency but only after starting the engines. If a starting battery is empty, you can also use its emergency parallel switch to connect it in parallel with the domestic batteries.

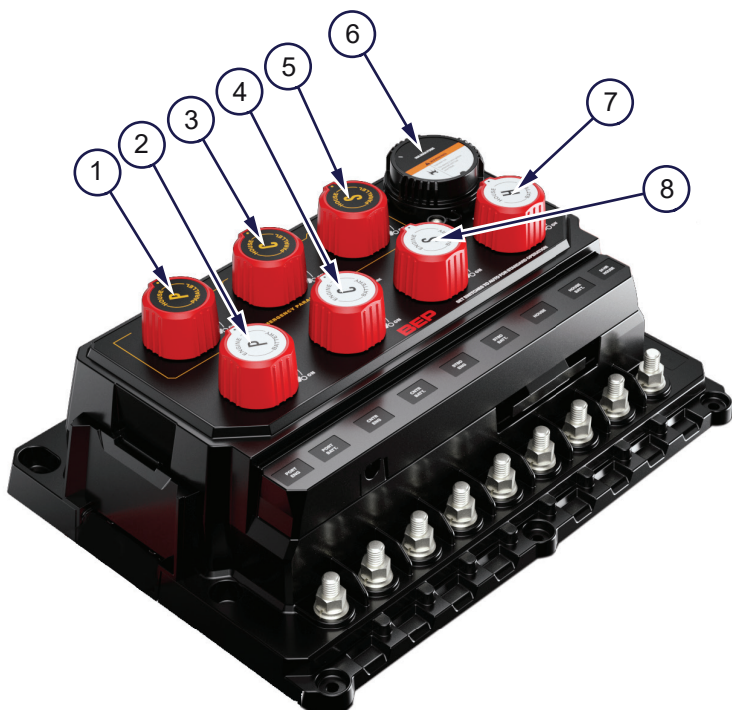

Figure 5.2 - Battery hub

- | | | | |
|---|---|---|--|
| 1 | Emergency parallel switch for port engine battery | 5 | Emergency parallel switch for starboard engine battery |
| 2 | Parallel switch for port engine battery | 6 | Fuse cover |
| 3 | Emergency parallel switch for bow thruster and anchor winch battery | 7 | Parallel switch for house batteries |
| 4 | Parallel switch for bow thruster and anchor winch battery | 8 | Parallel switch for starboard engine battery |

Related information

[4.2.6 Fuse panel](#) on page 42

[4.2.7 Battery control panel](#) on page 43

5.1.3.1 Charging batteries

The batteries charge automatically when the engines are running or when your boat is connected to the shore power.

⚠ WARNING

Risk of electric shock, battery overheating, explosion, fire or harmful gases.

Do not use external charger on the boat.



- If there is a problem with the battery charging, call a qualified nautical electrician.

5.1.4 Shore power

When onshore, you can run your boat's equipment and charge the batteries with the 110 V or 230 V alternative current (AC) shore power.

The shore power saves you fuel as you do not need to run your engines to charge the batteries.

You can connect your boat from an external power source on shore to a shore power inlet on your boat with the special shore power cable (marine-grade three-conductor cable). Shore power connections to the shore power panel on your boat and to the power source at the dock are plug-in.

Related information

[4.2.8 Shore power panel](#) on page 44

5.1.4.1 Connecting shore power

Follow this procedure to connect the shore power cable to your boat.

DANGER

Risk of death, electric shock or injury.

Connect the shore power cable first to your boat and only then to the power supply onshore.

If you connect the cable in the wrong order and the live power cable comes into contact with water, people on board, nearby swimmers and marine life will be exposed to a potentially lethal electric shock.

DANGER

Risk of death, electric shock, injury or fire.

Do not alter shore power cable connectors. Use only cable connectors that are compatible with the shore power inlet on your boat and shore power receptacles.

Disconnect the shore power connection when the system is not in use.

NOTICE

Risk of damage to the electrical equipment on board.

Check the reverse polarity indicator on the shore power panel of your boat to make sure the polarity of the power source onshore matches your boat.



1. Turn the shore power main switch / Overcurrent protection on the fuse panel to the OFF position.
2. Turn the boat's on/off switches on the battery control panel to the OFF position.
3. Turn the dock side power switch to the OFF position.
4. Check that the shore power cable is intact and dry.
5. Connect the shore power cable into the boat receptacle.
6. Connect the cable to the power source at the dock.
7. Turn the dock side power switch to the ON position.
8. Turn the boat's on/off switches on the battery control panel to the ON position.
9. Turn the shore power main switch / Overcurrent protection on the fuse panel to the ON position.
10. Check that the **Reverse polarity** indicator on the shore power panel on your boat is green.
 - If the **Reverse polarity** indicator is red, disconnect the shore power cable immediately.

- Contact the shore power service provider to correct the polarity issue before re-connecting the shore power.
11. Check that the shore power indicator on the fuse panel on your boat is red.
 - If the indicator light is off, disconnect the shore power cable and find out the reason for the failed connection before proceeding.

Related information

[4.2.7 Battery control panel](#) on page 43

[4.2.6 Fuse panel](#) on page 42

[4.2.8 Shore power panel](#) on page 44

5.1.4.2 Disconnecting shore power

Follow this procedure to disconnect the shore power from your boat.



1. Turn the shore power main switch / Overcurrent protection on the fuse panel to the OFF position
2. Turn the boat's on/off switches on the battery control panel to the OFF position
3. Turn the dock side power switch to the OFF position.
4. Disconnect the shore power cable from the shore power source.
5. Disconnect the shore power inlet on your boat.



Close the shore power inlet cover tightly.

6. Check that the shore power indicator light in the fuse panel is off.

5.1.5 Generator replacement system

The optional generator replacement system gives you extended use of 110 V or 230 V power to run the electrical appliances and equipment on your boat when you have no access to shore power.

The generator replacement system is located in the aft technical compartment. The system consists of a high-capacity 500 Ah battery pack (can be expanded to 1000 Ah) and a charger / inverter unit. Depending on your choice of equipment, the optional shore power can be used to charge the battery pack of the system.

You can monitor the charge level of the battery pack and the status of the generator replacement system with an application on the multifunction display on the helm station.

It is important to monitor the charge level. If the charge level of the battery pack of the generator replacement system runs too low, or if there is a fault in the system, the system shuts itself down automatically. When shutting down, the safety relay switch of the battery pack switches automatically to the OFF position and the 110 V and 230 V equipment turn off.

Check the manufacturer's manuals for details of the components of the generator replacement system.

When the boat is not used for an extended period of time, put the safety relay switch to the OFF position.

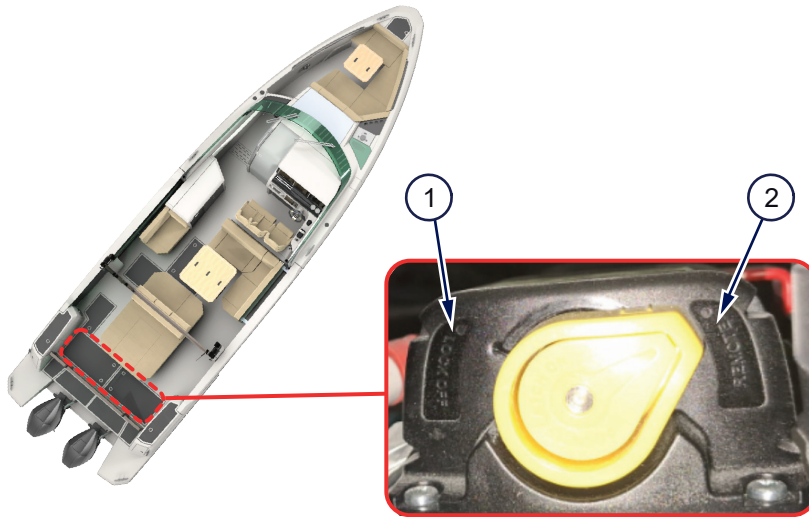

Figure 5.3 - Battery pack safety relay switch

- 1 Safety relay switch in OFF position
- 2 Safety relay switch in REMOTE position

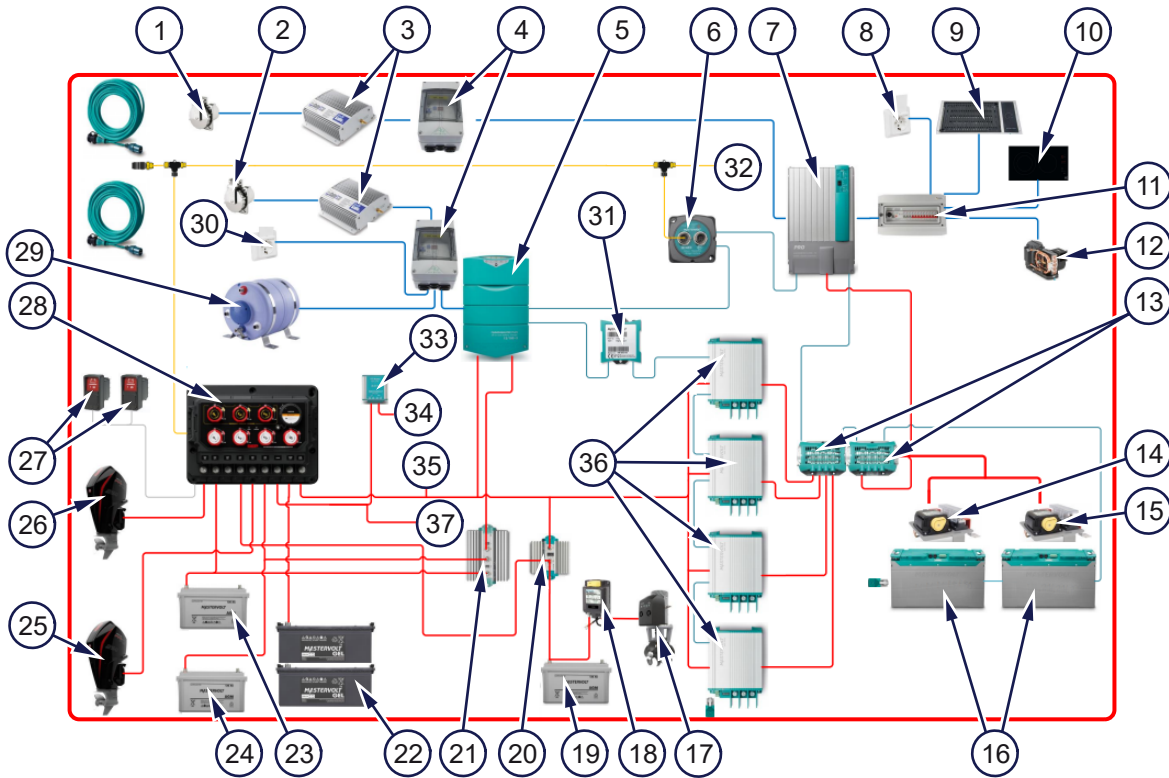

Figure 5.4 - Electrical system and generator replacement system

- | | | | |
|----|---|----|------------------------------------|
| 1 | Shore power inlet 1 | 20 | Charging relay |
| 2 | Shore power inlet 2 | 21 | Battery isolator |
| 3 | Galvanic isolators | 22 | Domestic service (house) batteries |
| 4 | Inlet fuse boxes | 23 | Port engine battery |
| 5 | Battery charger | 24 | Starboard engine battery |
| 6 | Czone bridge | 25 | Starboard engine |
| 7 | Generator replacement system charger / inverter | 26 | Port engine |
| 8 | Sockets | 27 | Battery switches |
| 9 | Grill | 28 | Battery management system |
| 10 | Stove | 29 | Boiler |
| 11 | Fuse box | 30 | Sockets |
| 12 | Air conditioning | 31 | Fuse box |
| 13 | DC distribution unit | 32 | Connection to navigation network |
| 14 | Safety relay switch | 33 | DC-DC converter |
| 15 | Safety relay switch | 34 | Power for navigation network |
| 16 | Generator replacement system battery pack | 35 | DC power supply |
| 17 | Bow thruster / Anchor winch | 36 | DC-DC converters |
| 18 | Bow thruster and anchor winch fuse switch | 37 | Switched-mode DC power supply |
| 19 | Auxiliary battery for bow thruster / anchor winch | | |

Related information

[4.2.6 Fuse panel](#) on page 42

5.1.5.1 Using the generator replacement system and backup power supply

Normally, you do not need to do anything else about the generator replacement system but keep an eye on the charge level of the battery pack with the CZone application, charge the battery pack before the charge level is too low.



- If the charge level of the battery pack gets too low, or if there is a fault in the generator replacement system, the system shuts itself down. The CZone application shows the shut-down status of the generator replacement system.
- Switch the safety relay switch of the battery pack to ON position to enable charging of the battery pack.
- Run the engines to charge the battery pack and the other batteries on your boat, or connect the shore power if possible.

Related information

[4.2.6 Fuse panel](#) on page 42

5.2 Engine and steering system

You can steer the boat and control the engines, the Zipwake system and the bow thruster from the helm station controls.



Figure 5.5 - Engine and steering

1	Twin engines	3	Engine, zip wake system and bow thruster controls
2	Zip wake system	4	Bow thruster

Learn more

- How to use the engine controls, lanyard stop switch and how to trim your boat: [3.2 Driving and steering on page 23](#)

Related information

[4.2.1 Helm station controls on page 37](#)

5.2.1 Engine

The engine on your boat is a powerful, industry-leading outboard engine.

Before using the engine, check the engine manufacturer's manual for more detailed instructions for use and maintenance.

You can check your boat's engine model and serial number from the label on the engine. See Technical specification for the make and type of the engine(s) on your boat.

NOTICE

Risk of damage to the hull or engine fixing points.

Do not exceed the maximum engine power shown on your boat's builder's plate.

5.2.1.1 Starting the engine

Read the engine manufacturer's manual before starting the engine.

NOTICE

Neglecting the break-in period for a new engine may cause engine damage or result in poor engine performance.

For instructions for breaking in the engine as well as other more detailed instructions for using the engine, check the engine manufacturer's manual.



1. Before starting the engine, make sure there are no fuel or oil leaks and there is enough fuel in the tank.
2. Turn on the main switch.
3. Set the lanyard stop switch to the RUN position.
4. Check that the gear shift is in neutral.
5. Start the engine as described in the engine manufacturer's manual. If your boat has two engines, make sure to start them both.

5.2.2 Zipwake system

The Zipwake system controls the trimming and the running angle of your boat automatically to give you a smooth ride.

Learn more

- About the basics of trimming on your boat: [3.2 Driving and steering on page 23](#)

5.2.3 Bow thruster

A bow thruster provides lateral thrust and thus makes your boat easier to maneuver when docking and undocking.

The bow thruster shuts off automatically in 6 to 9 minutes after last use. Check the bow thruster manufacturer's manual for more details.

Check the engine manufacturer's manual for more detailed instructions for use and maintenance.

5.3 Fuel system

Your boat's engines run on gasoline. The optional heater system is powered by diesel fuel.

⚠ WARNING Hot engine parts could cause a fire if in contact with flammable materials.

Store equipment that contains gasoline only in compartments designed for this purpose.

Gasoline fuel system installed on your boats is designed to meet EPA regulations. The system prevents spit back when filling the tank and lowers the evaporative emissions through the tank and vent. The fuel system contains gasoline fumes detector system, fuel tank, fuel tank vent lines, fuel tank fill line and fuel feed lines.

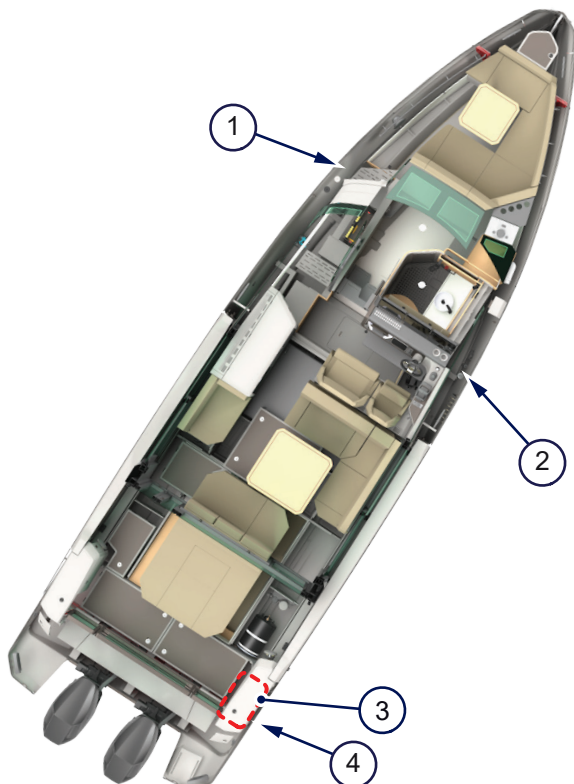

Figure 5.6 - Fuel system

- | | | | |
|---|-----------------------------------|---|---------------------------------|
| 1 | Gasoline fuel filling inlet | 3 | Diesel fuel filling inlet |
| 2 | Gasoline tank ventilation opening | 4 | Diesel tank ventilation opening |

You can monitor the fuel level in the tanks on the multifunction display. Always use high-quality fuels that meet the requirements stated in the engine and heater manufacturer's manuals.

⚠ CAUTION Risk of fire, explosion or material damage.

Avoid damaging the fuel lines on your boat. Pay attention to the location and condition of the fuel lines.

Check the engine and heater manufacturer's manuals for more information on:

- Instructions for use and care
- Detailed refueling instructions
- Suitable fuel types

Gasoline fumes detector system



Read the manufacturer's instructions provided in the Saxdor documentation bag.

Your boat may be equipped with gasoline fumes detector. The display unit of the system is installed near the helm. When gasoline fumes appear, red led light will occur and audible alarm will sound. In the event of alarm, immediately have all passengers exit cabins and boat if possible. Ventilate the bilge and carefully check all fuel lines and other potential sources of gasoline fume leaks. If leaks are identified shut off the fuel supply and make necessary repairs.

The gasoline fumes detector system should be tested periodically according to the manufacturer's recommendations. It is recommended to replace the gasoline fume sensors every three to four years.

Fuel tank

Aluminum fuel tank is installed in dedicated ventilated compartment.



The fuel level should be measured when the boat is not moving.

Fuel tank vent and fuel tank fill

Fuel fill deck fitting is marked GAS and allows refueling tank.

Fuel tank vent allows vapors to vent from tank during thermal expansion of fuel and while refueling. It allows fresh air flow into the tank during thermal contraction of fuel and when engine(s) are running. The vent prevents water from passing into fuel system.

Fuel tank ventilation line is equipped with carbon canister that absorbs hydrocarbons.

Fuel filter

Your boat's fuel system is equipped with fuel filter(s). Filters can be located in fuel feed line or as a part of engine set. Fuel filter(s) protect the engines from debris.

Fuel valve

The fuel tank's fuel intake is routed to the engine(s). There are manual valves for each fuel line. The manual fuel valves should be open during normal operation. In case of emergency or during storage, the valves should be closed.

Learn more

- How to minimize risk of fire: [2.5.4 Don't play with fire](#) on page 17

Related information

[8.1 Technical specification](#) on page 98

5.3.1 Selecting fuel type

Your engine(s) are designed to operate safely on fuel with a maximum of 10% ethanol.

Ethanol in gasoline attracts water and can absorb moisture from the atmosphere or marine environment through the fuel tank vent system. In time, it may cause fuel phase separation. Ethanol attaches itself to water molecules and drops to the bottom of fuel tank. If the ethanol/water phase reaches the fuel inlet, it can be drawn into the engine and cause poor performance or even damage.



- Avoid using fuel with more than 10% ethanol as the metal, rubber or plastic components in the engine and fuel system are not designed to tolerate the corrosive effects of an ethanol blend higher than 10%.
EPA currently allows using a maximum of 10% ethanol blended gasoline.
- Contact your local Saxdor dealer when replacing fuel system components.
Fuels with ethanol can damage the fuel system components not produced with acceptable ethanol-compatible materials.
- Purchase ethanol-free gasoline when possible to avoid phase separation.
- Keep the fuel tank filled between outings or before long-term or offseason storage.
 - a) Remove all fuel from the tank completely when preparing to store the boat for extended periods (of two months or more).
 - b) You can also store your boat with fresh ethanol-free fuel that has been treated with a marine-rated fuel stabilizer.
 - c) Shut off the fuel line using the manual valve installed on the fuel tank.

5.3.2 Refueling

Before refueling, ensure the engine is turned off, all electrical systems are shut down, and the boat is securely docked. Check the fuel tank capacity, use the correct fuel type, and have the proper equipment, such as a spill containment pad, to prevent accidents and maintain environmental safety.

⚠ WARNING

Risk of explosion.

Smoking or using any flame or spark-producing device near fuel can ignite the fuel and cause an explosion.

Never smoke or use any flame and spark-producing objects within 15.2 meters (50 feet) of the boat while fueling.

⚠ WARNING Risk of explosion.

Storing fuel or fuel-containing equipment in improper areas can lead to an explosion if exposed to sparks or flames.

Do not store fuel or fuel-containing equipment in cockpit compartments that are not specifically designated for fuel storage.

Gasoline is highly flammable and explosive, and its vapors can be ignited by an open flame or spark. If you smell gasoline, immediately turn off your boat's engines and all electrical systems and devices until the source of the odor is identified and the issue is resolved. The risk of a fuel fire increases during refueling.



- Never fuel the boat in unsafe conditions.
- Before starting to refuel, turn off the engines and all electrical systems and devices.
Close all doors, windows and hatches.
- Use only certified fuel containers and store them in designated areas.
Fuel storage must be well ventilated.
- While refueling, be aware of the static electricity generated when gasoline passes through the hose as it can ignite gasoline vapors.
 - To prevent static sparks, fill the fuel tank slowly and ensure direct contact between the fuel nozzle and tank opening.
 - To discharge any buildup static electricity, touch a metal part of the boat exterior.
- Never leave the nozzle unattended during the fuel fill.
When the fill nozzle shuts off, the tank is full.
- Secure the fill cap tightly after refueling.
- Check the boat surfaces for fuel spillage and clean if necessary.
Dispose rags or waste on shore.
- Ventilate areas where gasoline vapors may accumulate after refueling and before starting engines.
Open doors, windows and hatches.

5.4 Draining system

Your boat's draining system consists of an automatic bilge pump system with electric bilge pumps, a manual bilge pump and a draining system with drainage holes on the deck for rain water and wave splashes.

⚠ WARNING Risk of drowning!

The boat can sink or capsize if too much water gets into the boat as the bilge pump system can not remove it all.

The bilge pumping system is not designed for damage control. The combined capacity of the system is not intended to drain the craft in case of damage.

See the bilge pump manufacturer's manuals for instructions on how to use and maintain the pumps.

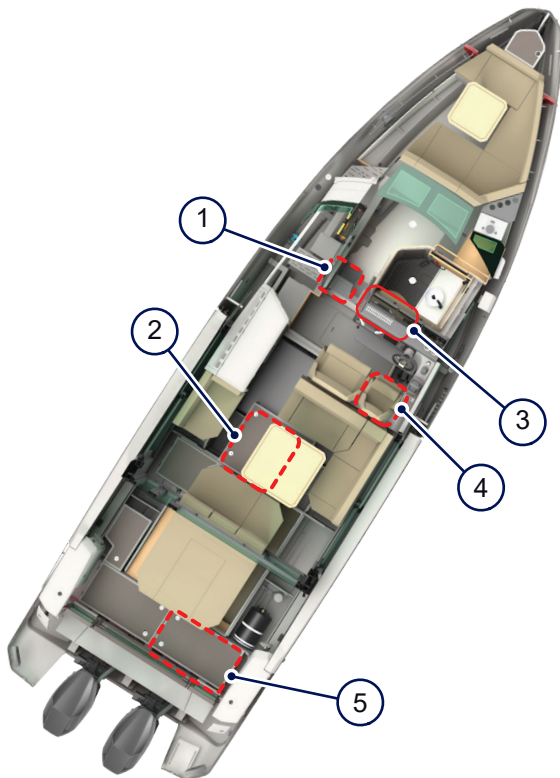

Figure 5.7 - Manual and automatic bilge pumps and controls

- | | | | |
|---|---|---|---|
| 1 | Access to FWD bilge pump in the bow of the boat | 4 | Manual bilge pump |
| 2 | Access to MID bilge pump in the midship of the boat | 5 | Access to AFT bilge pump in the aft of the boat |
| 3 | FWD, MID and AFT bilge pump controls | | |

Learn more

- How to ensure stability: [2.5.1 Avoid flooding and capsizing](#) on page 16

Related information

[4.6.3 Hull openings](#) on page 57

5.4.1 Using bilge pumps

If there is water in the bilge, the automatic bilge pump system activates and pumps out any extra water buildup from the bilge.

⚠ WARNING

The boat can sink if too much water gets into the boat.

If you suspect a leak, find out the reason and go ashore as soon as possible. The bilge pump system is not designed to pump out large amounts of water.

If there is a rapid increase in water accumulation, call rescue service.

Normally, you don't need to do anything other than monitor the water buildup. The automatic bilge pumps detect water in the bilge and automatically pump out water when required.

You can also control the automatic bilge pump system from the Navigation and lighting control panel on the steering console. A light on the panel illuminates when the pump is on. If the float on the bilge pump with the sensor rises to the upper position (indicating the water level is too high), the alarm buzzer sounds and a red light on the panel appears.



- If water starts building up, start the pump from the panel manually if the automatic start doesn't work. Use the manual pump if the automatic pump is out of order or out of power.

Related information

[4.2.1.1 Navigation and lighting control panel](#) on page 38

5.5 Fresh and waste water systems

Your boat can be equipped with a fresh water system and a waste water system. Depending on your choice of equipment, the waste water system can consist of separate grey water and black water systems.

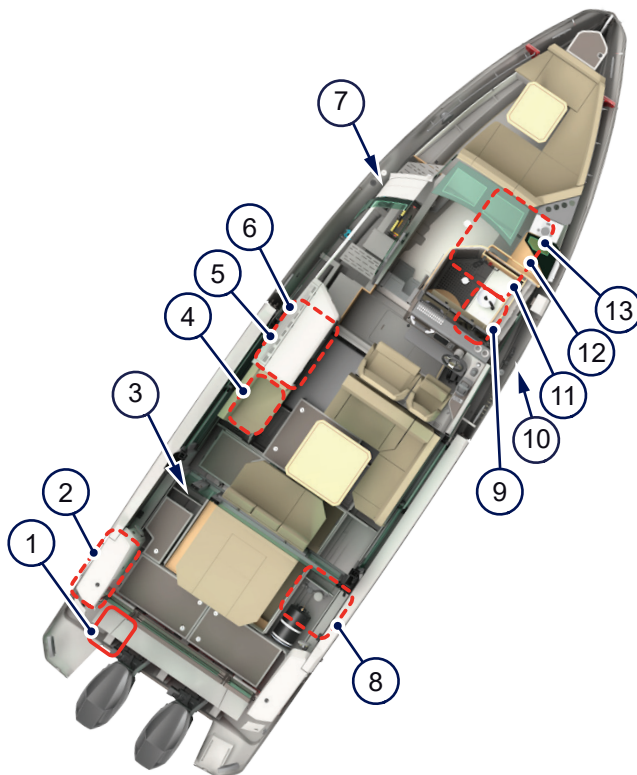

Figure 5.8 - Fresh, grey and black water systems

1	Fresh water shower and control panel	8	Water heater (access from the aft cabin)
2	Fresh water tap and sink	9	Black water tank
3	Grey water discharge outlet	10	Black water discharge outlet
4	Grey water tank	11	Toilet and toilet compartment control panel
5	Fresh water tap and sink in wet bar	12	Fresh water tap, sink and bidet shower in toilet compartment
6	Fresh water tank	13	Fresh water shower in the toilet compartment
7	Fresh water filling inlet		

The fresh, grey and black water systems have each their own plumbing and tanks.

- The fresh water system provides water to the shower on the bathing platform, to the shower and bidet shower in the toilet compartment, and to the taps in the wet bar and in the toilet compartment.
- The water heater provides hot water.
- The grey water system collects waste water from the shower in the toilet compartment as well as from the sinks in the toilet compartment and wet bar. In addition, the grey water system collects the condensation water from the optional air conditioning equipment.
 - The grey water runs from the sinks to the holding tanks below the sinks, and from the toilet compartment shower to the holding tank under the front cabin stairs.
 - Use the **Grey water pump** button on the toilet compartment control panel to pump the grey water from the holding tanks to the separate grey water tank. Use the pump regularly to ensure the grey water system works properly.
- The black water system collects the waste water from the toilet.
- The toilet operates electrically. The electrical toilet uses fresh water for flushing.



When you leave the boat unused for a longer period of time or store the boat over winter, the fresh and waste water systems can build up bacteria and impurities, or freeze in cold weather. Before you leave or store your boat, empty the fresh and waste water systems and tanks and flush them with fresh water.

5.5.1 Using the fresh water system

These instructions help you to use the fresh water system and to keep it clean.



- Fill the fresh water tank from the filling inlet marked with the text **Water**. To ensure you always have enough fresh water, top up the tank whenever you have the chance.
- If the water pressure is low, press the **Fresh water pump** button on the toilet compartment control panel to switch on the fresh water pump. The button for the fresh water pump is also available on the fresh water control panel on the bathing platform. The pump switches off automatically when the system has generated enough water pressure.
- Empty, flush and refill the tank with fresh water at regular intervals to prevent a buildup of bacteria and impurities.

Related information

[4.2.3 Toilet compartment control panel](#) on page 40

5.5.2 Using the toilet

Your boat may be equipped with electrically operated marine toilet.



- Press the **Toilet flush** button in the toilet compartment control panel to flush waste to the holding tank.

NOTICE

Risk of damage to the waste disposal system and harm o the environment.

Never flush facial tissue, paper towels, or sanitary napkins in the marine toilet as they can damage the system and harm the environment.

Related information

[4.2.3 Toilet compartment control panel](#) on page 40

5.5.3 Accessing seacocks

Your boat has multiple seacocks. Check here how to access them.



- Open the aft technical compartment hatch behind the Mastervolt batteries to access the port side aft seacocks.
- Open the aft technical compartment hatch behind the engine batteries or Webasto fuel tank to access the starboard drainage seacock.
- Open the hatch below the side console panel to access the starboard side openings.
- Open the hatch behind the ventilation grate behind the stairs in the front cabin to access the starboard optional AC seacock.
- Open the inspection hatch in the floor behind the stairs in the front cabin to access the AC system seacock and the black water seacock.
- Open the inspection hatches in the front cabin port locker to access the port side seacocks.

Related information

[4.6.5 Seacocks](#) on page 59

5.5.4 Using seacocks

Manually operate the seacocks to control the water flow into or out of your boat.

⚠ WARNING Risk of flooding.

Getting water inside the boat increases the risk of flooding.

Keep seacocks closed when not needed for operation to minimize the risk of flooding (for example water inlet of toilet flushing line).



1. Locate the seacock that you want to open or close.
The handle may be a lever or a round knob.
2. Turn the handle.
 - To open the valve turn the handle a quarter turn (90 degrees) in the direction of the water flow. The handle is fully open when the handle aligns with the flow direction.
 - To close the valve turn the handle a quarter turn (90 degrees) in the direction opposite to the water flow.
3. Check that the seacock is working properly.
 - Confirm that the water is flowing freely through the seacock.
 - If it is difficult to turn the handle or if there is resistance, inspect for any debris or corrosion.

Related information

[4.6.5 Seacocks](#) on page 59

5.5.5 Emptying the waste water tank using the waste discharge outlet

Always empty the waste water tank into a fixed waste water tank onshore.

CAUTION Pollution and health hazard.

Emptying waste water tanks into the water can cause water eutrophication and visual pollution in coastal areas.

Do not empty the waste tanks into the waters where it is not allowed by the law.

Plan your voyage in a way that you can always reach shore with proper fixed waste water tanks in good time before your waste water tanks get filled.

NOTICE Risk of damage to the waste disposal system.

Toilet paper can accumulate in the tank bottom making it more difficult to empty.

Empty the waste tanks before they become full.



1. Make sure the seacocks in the waste water openings on your boat are closed tightly.
2. Connect the suction hose from the shore tank to your boat's waste water discharge outlet marked with the text **Waste**.
3. Turn on the waste water pump of the shore tank.
4. Hold the suction hose tightly in place in the discharge outlet during the whole emptying process to prevent any accidental spilling onto the deck or into the water.
5. When the waste water tank is empty, turn off the waste water pump on the shore.
6. Disconnect the suction hose from the discharge outlet on your boat and close the outlet lid tightly.

Related information

[4.6.5 Seacocks](#) on page 59

[6 Respect the environment](#) on page 90

5.5.6 Emptying the waste water tank using the toilet pump button

Waste water tank can be emptied using the macerator discharge pump and seacock.



1. Open the black water seacock.
2. Press the **TOILET PUMP** button in the toilet compartment control panel to empty the holding tank.
3. When the tank is empty, release the **TOILET PUMP** button and close the black water seacock.

NOTICE Risk of damage to the waste disposal system.

Pressing the **TOILET PUMP** button with black water seacock closed can cause damage to the waste disposal system.

Before pressing the **TOILET PUMP** button, make sure that the black water seacock is in the open position. Keep the black water seacock in the closed position when not used.

Related information

[4.6.5 Seacocks](#) on page 59

[6 Respect the environment](#) on page 90

5.6 Navigation equipment

Your boat is equipped with the navigation equipment of your choice. See the equipment manufacturers' manuals for details for instructions for their use.

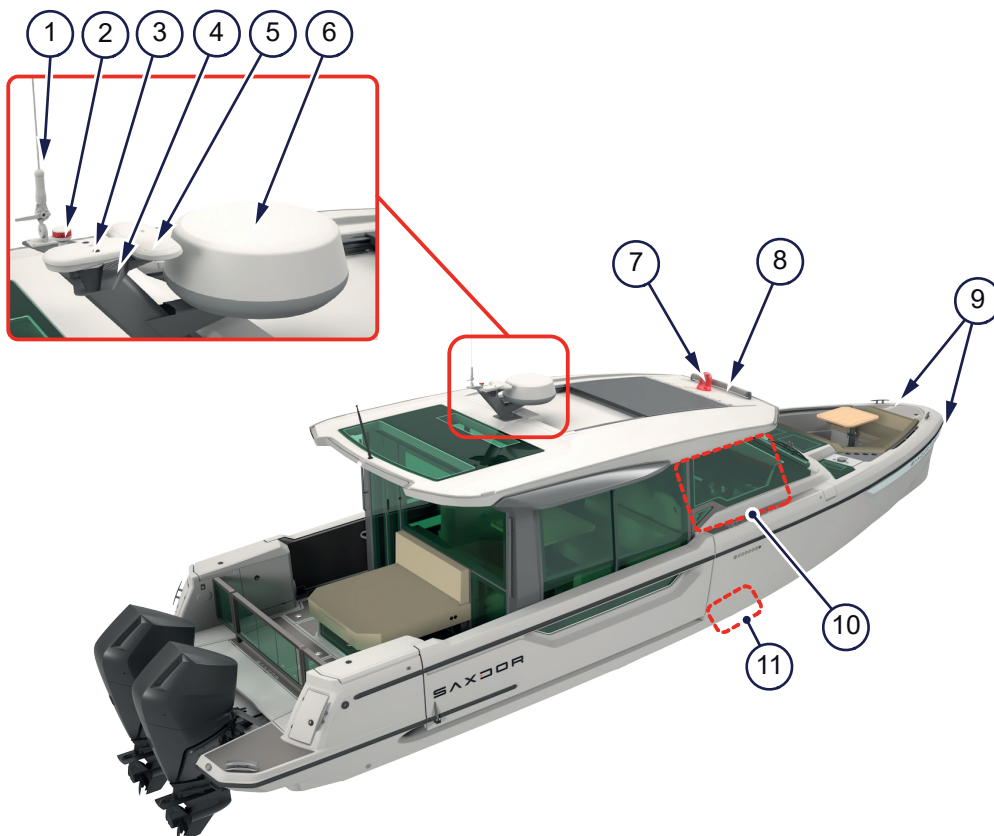

Figure 5.9 - Navigation equipment

- | | | | |
|---|---------------------------------|----|-------------------------------|
| 1 | VHF+AIS antenna | 7 | Night-vision camera |
| 2 | Navigation light | 8 | Light bar |
| 3 | Horn | 9 | Navigation lights |
| 4 | GPS antenna | 10 | Navigation equipment controls |
| 5 | Satellite compass for autopilot | 11 | Echosounder transducer |
| 6 | Radar dome | | |

Navigation lights, horn and windshield wiper

Your boat is equipped with LED navigation lights, an anchor light, a horn, a windshield wiper and a light bar on the front edge of the T-Top. You can find the control buttons for all these equipment on the helm station.

Multifunction displays

You can control the following navigation equipment via the multifunction displays on the helm station:

- Chartplotter
- Echosounder
- Radar
- Autopilot
- Night-vision camera
- GPS antenna and satellite compass

VHF and AIS

The VHF radio and AIS controls are available on the integrated VHF and AIS handset on the helm station.

Related information

[4.2.1 Helm station controls](#) on page 37

5.6.1 Accessing the navigation light fixtures

Here you can find information on how to access the navigation light fixtures of your boat.



- Access the bow navigation light fixtures via the anchor compartment hatch.
- Access the top navigation light fixtures from the roof.

Contact your Saxdor dealer for replacement light sources.

5.7 Anchor system

You can lower and lift the anchor with the electrical anchor winch, or you can use the anchor manually.

⚠ CAUTION Risk of injury or material damage.

Always lift the anchor up and secure it in the anchor box or lock it in the retaining system when you are not using the anchor.

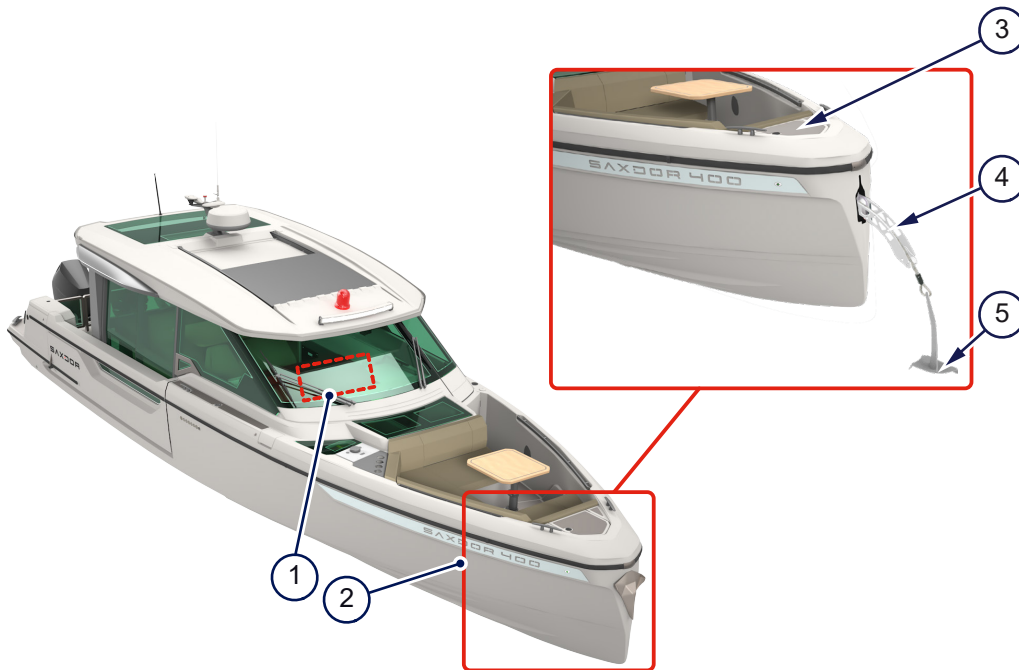

Figure 5.10 - Anchor system

- | | | | |
|---|-----------------------|---|----------------|
| 1 | Anchor winch controls | 4 | Anchor roller |
| 2 | Anchor lifted | 5 | Anchor lowered |
| 3 | Anchor box | | |

The anchor on your boat is located either in the anchor box, or in the optional electrical anchor retaining system under the anchor box. The retaining system consists of the electrical anchor winch and other components of the lifting/lowering mechanism, such as the anchor roller.

When you lower or lift the anchor electrically, the anchor roller extends from the bow and guides the anchor far enough from the bow so that the anchor and the anchor wire do not touch the bow and damage it.

Learn more

- About anchoring and anchor chains: [3.3 Mooring, towing and anchoring](#) on page 26

Related information

[4.2.1.1 Navigation and lighting control panel](#) on page 38

5.8 Comfort and fun

Find out here what fun and comforts your boat offers offshore, and how to protect the boat's interior and surfaces when in dock.

5.8.1 Heating and air-conditioning

The optional heating and air-conditioning system keeps you warm at night and cool by day.

⚠ WARNING Risk of fire or carbon monoxide accumulation.

Do not block the heater's exhaust pipe, ventilation or warm air outlet.

You can operate the heating and air-conditioning from the temperature control panel.

The air-conditioning unit takes water for the cooling circuit from the sea or lake through a hull opening. The condensate water from the air-conditioning system runs into the grey water tank.

The heater operates on diesel fuel.

Check the manufacturer's manual of the heating and air-conditioning system for more details about using the equipment.

Related information

[4.2.10 Temperature control panel](#) on page 46

[4.6.3 Hull openings](#) on page 57

[5.3 Fuel system](#) on page 72

[5.5 Fresh and waste water systems](#) on page 77

5.8.2 Wet bar and barbecue grill

The wet bar and the barbecue grill offer you full cooking facilities when onboard.

⚠ WARNING Risk of fire or overheating.

Do not close the lid of the wet bar when the cooktop is hot.

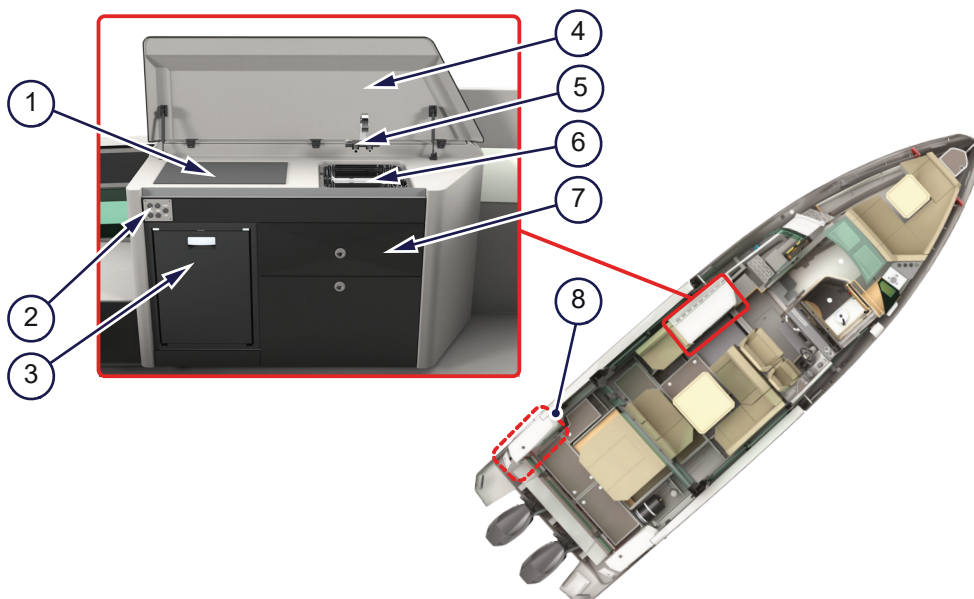

Figure 5.11 - Wet bar and barbecue grill

1	Cooktop	5	Fresh water tap and sink
2	Sofa and table control panel	6	Sink and chopping board
3	Fridge	7	Drawers
4	Wet bar lid	8	Barbecue grill

Cooking is quick and efficient with the cooktop on the wet bar.

Depending on your choice of equipment, you can power up your cooktop and barbecue grill like this:

- The electrical induction cooktop and the barbecue grill operate with shore power and with the battery capacity of the generator replacement system.
- The diesel-powered cooktop operates with diesel fuel.



For safety and hygiene reasons, close the lid when the cooktop has cooled down and when you are not using the wet bar.



It is a good idea to keep an eye on the battery capacity when cooking, and charge the battery when necessary. The cooktop is quick to drain the battery.

The fresh water tap and sink provide fresh water for cooking and doing the dishes.



If the water pressure is low, use the **Fresh water pump** button on the toilet compartment control panel to switch on the fresh water pump.

The fridges have their temperature control and on/off switches inside the fridge.

Related information

[4.2.3 Toilet compartment control panel](#) on page 40

[4.2.9 Cooktop control panel](#) on page 45

[5.5 Fresh and waste water systems](#) on page 77

5.8.3 Seating

Your boat offers different areas and setups for seating.

Your boat is equipped with three seats at the helm station: one for the driver and two for the front passengers. You can move the seats back and forth and lock / unlock the seat from the locking handle.

⚠ WARNING

Risk of death or serious injury.

Failure to lock the seat can cause you to be ejected from the seat.

Lock the cockpit seat when you drive.

Other seating setups:

- In the cockpit: a seat by the wet bar and a sofa setting around an adjustable table. You can lower and lift the table electrically.
- A part of the sofa setting is adjustable: you can change the seating direction electrically.
- There is a doorway hatch to the aft cabin under the sofa setting. The hatch serves as an emergency exit from the aft cabin.
- On the aft deck: a large sun bed sofa. There is an emergency exit from the aft cabin under the sofa.
- On the foredeck: sofa setting around a table. There is an emergency exit from the front cabin under the sofa.

Related information

[4.2.2 Sofa and table control panel](#) on page 39

[4.5.2 Safe seating and moving areas](#) on page 49

[4.5.1 Safety equipment and emergency exits](#) on page 48

5.8.4 Side terraces

The folding side terraces on both sides of your boat allow you to extend your offshore life onto a whole new level.

⚠ WARNING

Risk of injury, falling overboard or material damage.

Make sure there are no people or objects near or on the side terraces when you lower or lift them. Always lower the side terrace to the lowest locking position.

Lift the side terraces before you move the boat. It is prohibited to drive the boat unless the side terraces are locked in upright position.

⚠ CAUTION Risk of boat tipping or side terrace breaking down, risk of people or property falling into the water.

Always remember the balance of the boat and the durability of the side terrace.

Do not allow too many people to stay on the lowered side terrace.

Do not place too much load on the lowered side terrace.

Do not exceed the maximum permitted load on the side terraces. Check the technical specification for the maximum permitted load.

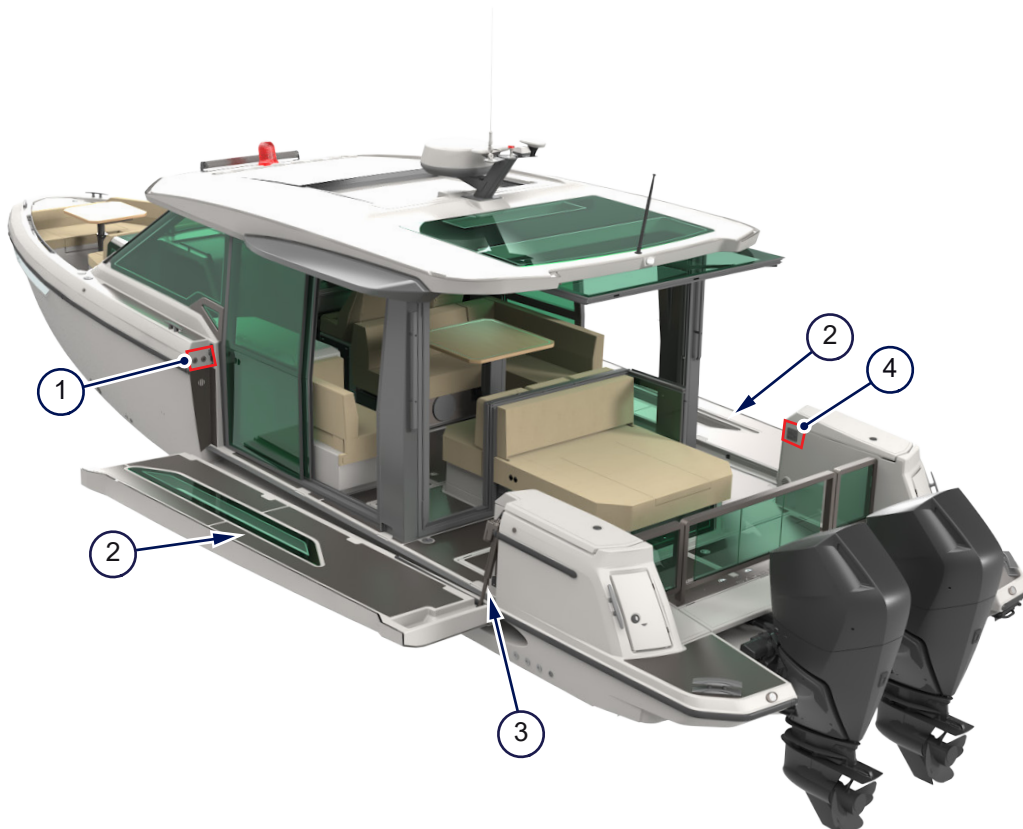

Figure 5.12 - Side terraces

- | | | | |
|---|----------------------------|---|--|
| 1 | Side terrace latches | 3 | Folding side terraces in the lowest locking position |
| 2 | Side terrace securing wire | 4 | Side terrace control panel |

You can lower and raise each side terrace separately from the side terrace control panel.

- Mechanical latches keep the folding side terraces locked in the upright position when you drive.
- When you lower the side terrace to the lowest locking position, the securing wire is straight and tight to show the proper position.
- The securing wire serves as a safety mechanism, as well. This ensures the terrace does not give way under your foot and cause you or your guests to fall into the water.

Related information

[4.2.5 Side terrace control panel](#) on page 41

5.8.4.1 Using the side terraces

You can lower and raise each folding side terrace separately.

⚠ WARNING Risk of death or serious injury.

Operating the boat with terraces lowered can lead to people falling into the water.

Do not use terraces while the engine is running. Always secure terraces in the closed position when the boat is underway.



1. Unlock the side terrace latches.
If you want to lower just one terrace, unlock the latch for that terrace only.
2. Lower the terraces from the side terrace control panel.
Press the locking button **Lock** and the arrow button of the port terrace or starboard terrace (**Terrace PORT** or **Terrace STB**) at the same time.
3. Lower the terraces to the lowest locking position so that the securing wire is straight and tight.
The electric motor of the terrace mechanism stops automatically when the terrace is in the lowest locking position.
4. When you want to raise the side terraces, press the **Lock** button and the **Terrace PORT** or **Terrace STB** arrow button at the same time.
The electric motor of the terrace mechanism stops automatically when the terrace is in the upright locking position.
5. Lock the side terrace latches.

Related information

[4.2.5 Side terrace control panel](#) on page 41

5.8.5 Sun shade

The sun shades keep you and your passengers cool when the boat is stationary.

⚠ CAUTION Risk of injury or material damage.

Do not drive the boat when the sun shade is up. The sun shade and mounting poles may tear off.

Do not use the sun shade in harsh weather conditions and in strong wind.

You can set up, attach and lock the sun shades to the mountings on the foredeck and on the aft deck.

5.8.6 Bathing ladder

The bathing ladder on the bathing platform allows swimmers to go into the water and reboard safely and unattended. In addition, it is a safe way to rescue people from the water.

⚠ WARNING

A rotating propeller may cause death or a serious injury.

Shut off the engine when there are people in the water near the boat.

Do not reboard the boat when the engine is running.

Do not use the engine's cavitation plates for reboarding the boat.

⚠ CAUTION

Risk of injury or material damage.

Do not block access to the bathing ladder.

Do not drive the boat when the bathing ladder is down.

The bathing ladder is secured in place under the bathing platform. The bathing ladder is easy to pull out and extend even when you are in the water.

Learn more

- How to rescue people from the water: [2.6.3 Man overboard!](#) on page 20
- Where the bathing ladder is located: [4.1.6 Bathing platform](#) on page 35

5.8.7 Harbor covers

When you store your boat for the off-season, protect the seats and other surfaces from the sun, rain and dirt with harbor covers.

⚠ CAUTION

Risk of injury or material damage.

Do not use the harbor covers when driving. The covers may tear off in strong wind.

When storing the boat, attach the harbor covers to the channels underneath the T-Top and to the windshield frame.

5.8.8 Lighting and audio

Lighting

Your boat is equipped with LED lighting in the front cabin, on the cockpit and on the deck. You can adjust cockpit and deck lights from the control panel at the helm station.

Audio

Depending on the options you choose, your boat can be equipped with a Hi-fi audio system with the audio device, amplifier, subwoofer and speakers.

Check the audio equipment manufacturer's manuals for more information on the features and the use of the equipment.

Related information

[4.2.1.1 Navigation and lighting control panel](#) on page 38

6 Respect the environment

As the proud captain of a Saxdor boat, you have the responsibility to protect the marine environment. Ensure that you and your crew comply with the environmental laws like the International Convention for the Prevention of Pollution from marine vessels (MARPOL) and the local regulations in the area where you are boating.

6.1 Handling waste properly



Follow these tips to ensure you are handling your boating waste properly.

- Never throw garbage or waste into the sea or on the shore.
- Never pour down sink substances that are harmful to the environment - even if your boat had a grey water tank that ensures that water does not drain directly into the sea from the sink.
- Never pump dirty bilge water into the sea. For dirty bilge water, use a separate container and dispose of it as hazardous waste.
- Check the bilge water regularly for contaminants like oil, diesel, or glycol.
- Do not empty the waste water tanks into the sea. Constantly monitor the level of your waste water tanks and plan your trip so that you can always empty the tanks at port.

6.2 Avoiding contaminant spills



Follow these tips to avoid contaminant spills.

- Take care not to spill fuel, oil, detergents or solvents into the sea. Keep oil absorbent material on board at all times in case of a spill or leakage.
- Do not overfill the fuel tank. Make sure fuel does not overflow into the sea from the fuel ventilation opening.
- When caring for your boat, do not use substances harmful to the environment. Follow the local regulations concerning acceptable cleaning agents, waxes and paints.

6.3 Minimizing emissions and disturbance



Follow these tips to minimize emissions and disturbance when boating.

- Have the engine and propeller serviced by an authorised professional.
- Adjust your speed to avoid disturbance and shoreline erosion caused by waves that your boat creates.
- To reduce fuel consumption and to avoid disturbing others, do not idle or rev the engine unnecessarily.
- Do not load your boat with unnecessary items as extra weight uses more fuel.
- Keep the hull of your boat clean to reduce the amount of drag.
- Maintain the optimal trim of the boat as it affects the fuel consumption.

6.4 Preventing the spreading of aquatic invasive species

Follow these tips to prevent the spreading of harmful watercraft-borne marine life.



Figure 6.1 - ABYC T-32 aquatic invasive species label

The American Boat and Yacht Council (ABYC) has classified certain species of marine life as harmful aquatic invasive species (AIS). These species are plants, animals and microbes which can attach themselves to your boat or to your trailer, or which can find their way to the water systems or water deposits on your boat.



- Take necessary precaution when moving between different bodies of water to prevent the spreading of the AIS.
- Take necessary purification measures for your boat to eradicate the AIS.

The purification measures include (but not limited to) physical cleaning, draining and drying, as well as decontamination of the surfaces and water systems or water deposits on your boat.

- To clean the boat, inspect and remove all aquatic plants, animals, mud and debris from the boat, engine, trailer, anchor and any watersports equipment. Rinse, scrub or wash, as appropriate, impurities away from the hull openings and seacocks. Use hot water, when possible. Flush the engine according to the manufacturer's recommendation.
 - To drain the boat, completely drain all the water from the boat and its compartments, including but not limited to bilge, wells, lockers, ballast tanks and engines.
 - To prevent the spreading of the AIS after purification of the boat, allow the boat dry completely before visiting any other bodies of water.
- Contact your Saxdor dealer for more information about the prevention of the AIS.

7 Care for your boat

This section provides only general guidance for the maintenance of your boat. For more details, check the equipment manufacturer's manuals, which are included in the Saxdor documentation bag.



Saxdor Yachts cannot be held responsible for modifications not approved by the company.

Always use trained and competent people for maintenance, repair or modifications.

Modifications that may affect the safety characteristics of the boat need to be assessed, executed and documented by competent people.

To ensure safety, and the validity of your boat's warranty, have the boat regularly and professionally maintained and serviced. Contact your Saxdor dealer for information about authorized boat service providers.

Make sure your Saxdor dealer has registered your boat's engine and other third party equipment with the equipment manufacturers to activate the warranty. Warranty registration helps you in any service related issues with the equipment.

Routine inspection, service and maintenance of your boat and all its systems and components are crucial for your safety. Intervals between necessary inspections may vary depending on the environment where the boat is used.

7.1 Maintaining your boat's gel coat surface

Your boat's gel coat is exposed to environmental conditions such as saltwater, temperature variation, UV exposure and marine life that can cause it to deteriorate. Protect your boat's gel coat surface as any growth affects the boats' performance and appearance.

CAUTION Risk of injury or material damage.

Chemicals and harmful gases may be dangerous to people or may cause material damage to your boat.

When using chemicals, read the manufacturer's instructions regarding safety and maintenance.

Wear protective equipment and work in a well-ventilated space.

NOTICE Risk of damage to the hull.

Using detergents containing chlorine, acids or similar can damage the hull.

Use only cleaning products that are intended for marine use and free from chlorine, acids or similar.



- Wash and clean your boat regularly.
The best practice is to do this after every trip.
- If a pressure washer is used for cleaning the gel coat surfaces, use a wide fan nozzle.

- a) Do not concentrate high pressure on a small surface area.
 - b) Do not spray water directly on electronic equipment as it may damage them.
 - c) Clean the gel coat surfaces using warm fresh water and a mild detergent intended for the marine industry. You can use a brush with soft bristles.
- Clean any growth from the gel coat surface immediately after lifting your boat from water. If the growth is allowed to dry, it is much harder to remove. For cleaning, you may use a coarse towel or a brush with soft bristles. If the growth is more severe, ask for professional assistance.
 - Inspect the gel coat surface for signs of debris, deterioration or changes in color. Small scratches or discolorations can be fixed by buffing or polishing. Severe scratches, discoloration or oxidation may require wet sanding before buffing, polishing and waxing. Use a buffing compound before using a polishing compound. Follow the product instructions and recommendations.
 - Wax the boat twice a year or annually if it is not used all year. Regular waxing protects the gel coat surface and keeps it in good condition.
 - Clean the surface before waxing.
 - Apply wax and wait until it looks dry.
 - Buff the wax and finish by wiping all residues.
- Use products designed for marine gel coat and read the manufacturer's instructions and recommendations.

7.2 Applying antifouling paint to your boat's hull

Since your boat spends most of the season in the water, applying antifouling paint to the bottom is a good idea. This special paint prevents aquatic organisms from attaching to the hull, slows their growth, and helps maintain your boat's performance and appearance.

⚠ CAUTION Risk of injury or material damage.

Chemicals and harmful gases may be dangerous to people or may cause material damage to your boat.

Wear protective equipment when applying antifouling paint. If your paint contains solvents, work in well-ventilated space.

Make sure to read all the labels, data sheet and manufacturer's instructions and recommendations before starting to apply antifouling paint.



Antifouling may contain biocides. Make sure that they are allowed in the country where your boat is docked.



1. Remove all hardware from the boat before applying antifouling paint. Use tape to cover any items that cannot be removed and may be affected by paint.
2. Clean surfaces and remove greasy and waxy layers.
3. Fill and repair any cracks and corrosion.
4. Sand the boat thoroughly. Always sand away all the old paint.

5. Apply antifouling paint to your boat's hull.

Antifouling paint wears off gradually over time. Usually it must be replaced annually. Humidity and weather affect how and when the new paint needs to be applied. Make sure to always use the same antifouling paint, otherwise all old paint must be removed before applying a different paint.

7.3 Maintaining canvas covers

Your boat may be equipped with canvas covers to protect the boat's upholstery from environmental conditions. Regular care ensures the covers remain waterproof, durable, and properly fitted, helping to preserve the boat's interior, prevent mold and mildew buildup, and extend the lifespan of the covers.



- Install the canvas covers tightly to prevent flapping.
- Clean the canvases regularly, at least twice a year, to prevent dirt from accumulating and to keep canvases in good condition.
All fabrics support growth of mold and mildew. Use anti-microbial treatments to protect the base surface and to prevent spore growth.
- Rinse and soak the canvases with fresh ambient temperature water to clean it and brush off any loose dirt.
Use only gentle cleaning products such as natural soap.
- Dry out the canvases completely after cleaning.
- Store the canvases in dry indoor conditions for the winter. Canvases must not be stored in the boat.

7.4 Maintaining upholstery

Your boat's upholstery is exposed to humidity, salt residue, dirt and UV radiation. Maintain the upholstery regularly to retain their texture.

Your upholstery is not waterproof, it may absorb and hold water.



- Do not leave the upholstery to heavy, prolonged rain.
- Do not leave standing water on top of the upholstery.
- Keep the upholstery dry and make sure that water doesn't accumulate between the cushions.
- Clean the upholstery with fresh ambient temperature water and brush off any loose dirt.
Use only gentle cleaning products such as natural soap.
- Dry the upholstery completely after cleaning.

7.5 Cleaning your boat's windshield and windows

Keeping your boat's windshield and windows clean is essential for maximizing visibility and ensuring safety.

NOTICE

Risk of damage to windshield and windows.

Do not use abrasives, harsh chemicals or scrapers on glass.

Do not use solvents such as acetone, silicone spray, glass cleaning solutions, benzine or harsh detergents on acrylic.



- Clean the tempered glass windshield and windows by using commercially available glass cleaners.
- Dry the windshield and windows with a soft fabric.
- Wash the acrylic windshield and windows from both sides using a mild soap and rinse with cold fresh water.
- Clean the acrylic windshield and windows by rinsing with fresh water to remove dirt and dust.
- To keep the acrylic windshield and windows in good condition, you may use a poly-carbonate protective cleaner.

7.6 Maintaining metal components

Your boat's metal components, both above and below the waterline, require regular maintenance to prevent rust and corrosion caused by the humid atmosphere and saltwater exposure. Routine inspections are essential to detect signs of degradation.

WARNING Risk of death or serious injury.

Corrosion can affect any metal component of the boat if not kept clean and dry when not in use. Deterioration from corrosion can cause component failure, leading to serious injury or death.

Always ensure that all metal components are clean and dry when the boat is not in use.

NOTICE Risk of damage to the metal components.

Never use abrasive cleaners, detergents or soft scrub type cleaners.

Never use abrasive pads, brushes or sponges to attempt to remove stubborn stains.

Never use strong solvents or detergents which contain chlorine, and never use silver cleaners.



- Clean all metal components frequently and keep them dry.
Clean the metal components during the general boat cleaning.
- Pay attention to signs of corrosion.
Treat or replace any corroded components immediately.
- Inspect all underwater metal parts annually for signs of corrosion.
Underwater metal components are subject to electrolysis and galvanic corrosion, which can cause a white, powdery substance to form on metal surfaces, leading to a greenish color or deep pitting on surfaces.
- Replace underwater openings and seacocks every 5 years.



Deterioration caused by corrosion is not covered by Saxdor warranty.

7.7 Maintaining lanyard stop switch

The lanyard stop switch is a vital safety feature on your boat. Regular inspection and maintenance are essential to ensure it functions reliably.

- 
- Inspect the lanyard stop switch monthly to ensure it operates correctly and is free from damage.
 - a) Pull the lanyard while the engine is running.
 - b) If the engine doesn't stop, contact your local Saxdor dealer for lanyard stop switch replacement.

7.8 Maintaining deck floors

Your boat may be equipped with foam flooring with non-slip surface. Keeping flooring in good condition is crucial to maintain its properties.

- 
- Use water, a gentle cleaning product such as soap, and a soft wipe to clean the floors.
 - Do not use harsh detergents like acetone, bleach, oxalic acid or chemicals containing flammable and corrosive agents.
 - Do not use cleaning equipment that may damage the flooring surface such as hard bristle brushes. Pressurized washer may be used for cleaning only when keeping a minimum distance of 50 cm (1.64 feet).
 - Clean the floor regularly and after each heavy use.



Mechanical or any other dents and shoe marks on the deck floors are not covered by the warranty.

7.9 Maintaining fresh and waste water systems

Regular maintenance of your boat's fresh and waste water systems is essential to ensure safe drinking water, prevent buildup and odors, and protect against damage, keeping your boat in optimal condition.

- 
- Cycle the macerator seacock handle open and closed to ensure proper operation of the seacock prior to each use and at regularly scheduled intervals.

If the macerator pump gets stuck, contact your Saxdor dealer for repair.
 - Inspect the hose connections, fittings and electrical wiring of pumps annually.
 - Check the systems for leakage.

If the water pump is equipped with a filter, inspect and clean it annually.
 - Clean the marine toilet with a mild cleaner.

Do not use harsh detergents that can damage the system's plastic or rubber parts.
 - Clean and flush the fresh water and waste systems thoroughly before winter storage.

Make sure all tanks are empty, both systems must be completely drained of water.
 - Read the component manufacturer's instructions and recommendations.

7.10 Maintaining bilge pumps

Maintaining your boat's bilge pumps is important to ensure they function properly in removing water from the bilge. Regular maintenance helps prevent pump failure, which could lead to water accumulation, flooding, or damage to the boat's electrical system, ensuring safety and reliability while on the water.

NOTICE

Risk of damage to bilge pumps.

Debris in bilge pumps can cause pumps to clog.

Check the function of all bilge pumps at regular intervals. Clear the pump inlets from debris.



- Test the operation of bilge pumps periodically by activating the manual switch and observing the water discharge.
- If your bilge pump gets activated frequently or continuously, investigate the source of the leak.
 - a) Check for hull damage, systems leaks, missing drains, and so on.
 - b) If your bilge pump does not discharge, check the bilge pump, hose and hull openings and seacocks for debris.
- Inspect the bilge pumps by removing the basket and remove any debris.
- Keep the bilge clean and dry for winter storage.
- Read the component manufacturer's instructions and recommendations.

7.11 Maintaining fuel system

Maintaining your boat's fuel system is crucial for optimal engine performance, fuel efficiency and reliability. Regular upkeep ensures smooth operation and extends the life of the engine.



- Check the fuel tank compartment floor and fuel system compartments for liquid fuel and gasoline odor before each departure.

If any leak or strong odor occurs, do not turn on the engines or any electrical device.

Open all hatches to ventilate.

- Inspect the fuel system for leaks annually. Check the condition of fuel tank, fuel system components and all hoses.

Any leak, visible crack, deterioration or corrosion indicates that professional inspection or repair is required.
- Check the fuel tank compartment floor for accumulated liquids twice a year.

Remove accumulated liquid by using bilge pump (if equipped) or by wet-dry vacuum cleaner.
- Check the fuel system for presence of water by inspecting the fuel filter content twice a month.

If you notice any water, replace the fuel filter and dry the fuel tank.

8 The details

Check here the relevant number information for your boat.

This information is handy when planning and provisioning for your next trip, and on the way, too.

8.1 Technical specification

Table 8.1 - General specifications

Description	Value
Boat model	Saxdor 400 GTC (Main cabin model)
Purpose of the boat	Recreational
Engine	Mercury twin outboard engines max. 800 combined HP
Maximum recommended engine power	596 kW / 800 HP
Maximum speed	45 kn
Engine mounting	Engine with a shaft of 63 cm (25 in) is mounted in the 2nd hole from the top. Engines should be spaced 101 cm (40 in) apart.
Recommended fuel for the engine	See the engine manufacturer's manual
Recommended fuel for the heater	See the heater manufacturer's manual
Maximum number of people on board	
• Design category B	12
Battery DC system voltage	12 V
Shore power AC system voltage	110 V or 230 V
Breaking strength of strong points	50 kN

Table 8.2 - Weights

Description	Category B	
Light craft condition (m_{LC})	7709 kg	16995 lb
Maximum load on the builder's plate (m_{MBP})	1260 kg	2778 lb
Full load	10237 kg	225619 lb
Tonnage	8200 kg	18078 lb
Weight of the maximum recommended number of people (included on the builder's plate) ¹⁾	900 kg	1984 lb

Description	Category B	
Luggage and other personal belongings (included on the builder's plate)	330 kg	728 lb
Inflatable life raft ²⁾	30 kg	66 lb
Engine (recommended maximum)	680 kg	1499 lb
Fuel	750 kg	1653 lb
Fresh water	170 kg	375 lb
Grey water	105 kg	231 lb
Black water	60 kg	132 lb
Total weight of liquids in fixed tanks when full	1025 kg	2260 lb
Weight of the boat when towed on a trailer (m_T) ³⁾	7918.7 kg	17458 lb
Margin for future additional equipment	30 kg	66 lb
Maximum permitted load on one side terrace	300 kg	661 lb
Maximum load condition	10237 kg	22569 lb
Loaded displacement mass ⁴⁾	10237 kg	22569 lb

- 1) Calculated average: one adult equals 75 kg / 165 lb, one child 37.5 kg / 83 lb.
- 2) Boat owner's responsibility to obtain
- 3) Items included in the m_T weight: structure, permanent internal and external equipment, engine, tanks and tank content. Items not included in the m_T weight: loose internal equipment, loose electronic and navigational equipment (e.g. charts), tools, spare parts, personal safety and life-saving equipment, provisions, bilge water, bait tanks.
- 4) Includes the weight of all persons onboard, all provisions and personal effects, any equipment not included in the light craft mass, cargo (if any) and all consumable liquids (water, fuel, etc.).

Table 8.3 - Tank capacities

Description	Value	
Gasoline (for engines)	1000 L	264 gal
Diesel (for optional heater)	25 L	6.6 gal
Fresh water	170 L	45 gal
Black water	60 L	15.9 gal
Grey water	105 L	27.7 gal

Table 8.4 - Bilge pump capacity

Description	Value	
Automatic	40 L/min	10.6 gal/min
Manual (45 strokes/minute)	40 L/min	10.6 gal/min

Table 8.5 - Lifting point locations

Dimension	Description	Value	
A	Minimum distance from the measuring point in the end of the keel to the lifting point in the bow	7.60 m	24.9 ft
B	Minimum distance from the measuring point in the end of the keel to the lifting point in the aft	0.80 m	2.6 ft

8.2 Boat dimensions

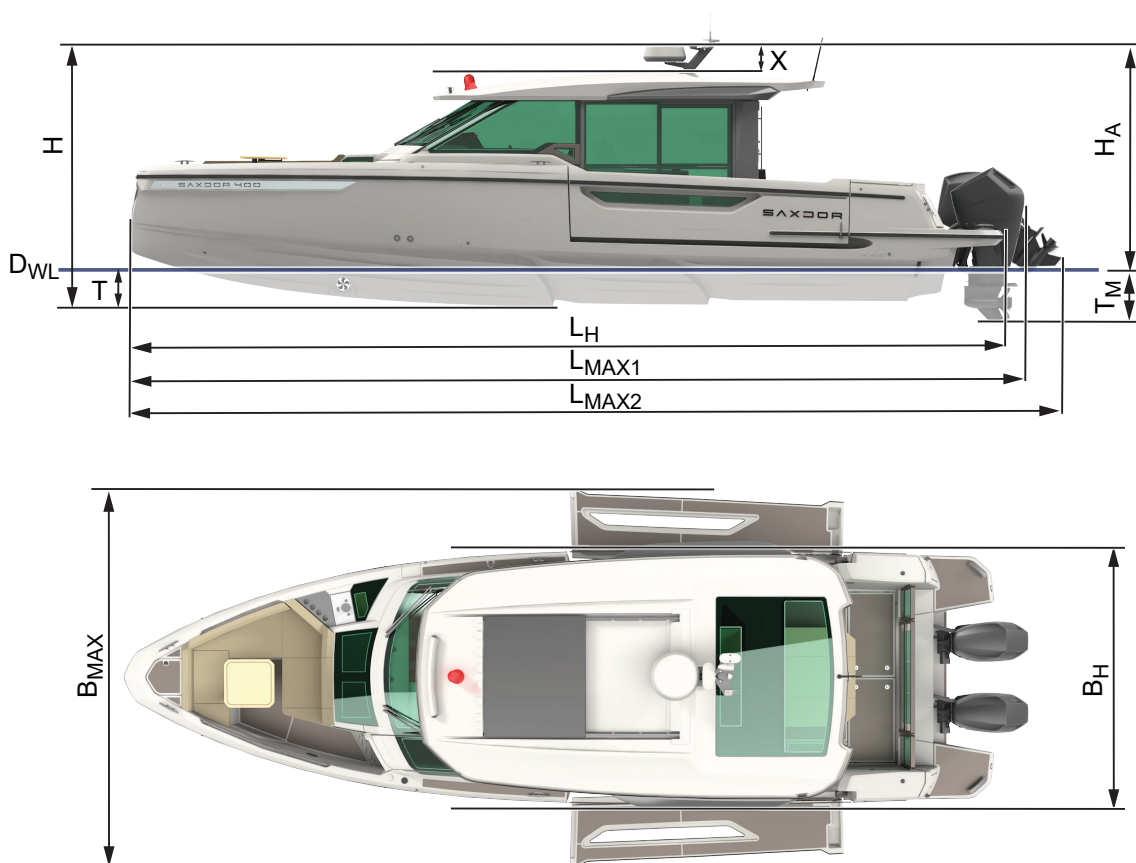

Figure 8.1 - Saxdor 400 GTC dimensions

Table 8.6 - Description of dimensions

Dimension	Description	Value	
D _{WL}	Design waterline	-	
H _A	Air draft: the height from the waterline to the highest non-removable part of the boat (radar/antennas/lights on the T-Top)	2.95 m	9.68 ft
H	Overall height: the height from the bottom of the hull to the highest non-removable part of the boat	3.68 m	12.07 ft
X	The height from the roof to the highest non-removable part of the boat	0.37 m	1.21 ft

Dimension	Description	Value	
L _H	Overall hull length: the overall length of the hull from the bow to the end of the bathing platform	12.4 m	40.68 ft
L _{MAX1}	Overall length of the boat with the outboard engines	12.69 m	41.63 ft
L _{MAX2}	Overall length of the boat with the outboard engines tilted up	13.12 m	43.04 ft
T	Draft: the measure from the waterline to the bottom of the keel	0.64 m	2.10 ft
T _M	Hull draft: the measure from the waterline to the lowest part of the engine (the fin-like skeg that protects the propeller)	0.96 m	3.15 ft
B _H	Beam: the width of the boat	3.5 m	11.48 ft
B _{MAX}	The width of the boat with the side terraces lowered	5.0 m	16.40 ft

9 Extras

Check here the relevant info about the warranty and qualification of your boat, as well links to the manufacturer's information about the different equipment on your boat.

9.1 Declaration of conformity

The declaration of conformity states that your boat meets all relevant requirements of all product safety directives applicable to the boat.

- You can find the declaration of conformity document in the Saxdor documentation bag.

9.2 Electrical wiring diagram

The electrical wiring diagram includes the drawings of all circuits and electrical connections on your boat.

- If you need a copy of the electrical wiring diagram, please contact your Saxdor dealer.

9.3 Warranty

The warranty states the guarantee of the integrity of your boat and the maker's responsibility of your boat.

- Check the warranty at www.saxdoryachts.com.

9.4 Warnings and cautions

Heed all the warnings and cautions in this manual! For your convenience, they are also listed here.

⚠ DANGER

Not heeding the limitations stated on the builder's plate can cause boat capsizing, swamping or sinking.

Do not exceed the maximum permitted engine power or number of persons on board.

Respect the conditions set out by the design category of your boat.

⚠ DANGER

Risk of death, serious injury or severe damage to your boat.

Sudden grounding from high speeds can cause serious injury or death and severe damage to your boat.

Rapid deceleration can cause occupants to crash the boat and to be ejected from the boat.

Be aware of your boat's minimal safe depth to avoid grounding.

⚠ DANGER

Risk of electric shock, fire or explosion.

Remember that water and electricity are a bad combination.

Let only a competent marine electrical technician carry out any installation, alteration or maintenance work to the electrical system.

⚠ DANGER

Risk of death, electric shock or injury.

Connect the shore power cable first to your boat and only then to the power supply onshore.

If you connect the cable in the wrong order and the live power cable comes into contact with water, people on board, nearby swimmers and marine life will be exposed to a potentially lethal electric shock.

⚠ DANGER

Risk of death, electric shock, injury or fire.

Do not alter shore power cable connectors. Use only cable connectors that are compatible with the shore power inlet on your boat and shore power receptacles.

Disconnect the shore power connection when the system is not in use.

⚠ WARNING

Risk of collision.

Do not operate the boat outside of inland waterways in foggy conditions, in poor visibility or at night.

⚠ WARNING

Neglecting the necessary safety precautions can risk lives.

Take safety seriously. Remember that you as the driver are responsible for the safety for others.

⚠ WARNING

Risk of drowning.

Neglecting to carry onboard and use life jackets in emergency can cause death and serious injury.

Make sure that your boat is equipped with proper number and type of life jackets.

Make sure that all persons on board, including yourself, are wearing a life jacket at all times.

⚠ WARNING

Risk of fire or explosion.

When replacing parts of the fire-fighting installation only matching components shall be used, bearing the same designation or being equivalent in their technical and fire resistant capabilities.

⚠ WARNING

Not respecting the design category limitations of your boat can put you and your passengers at risk.

Do not exceed the maximum permitted engine power or number of persons on board.

Ensure that the anticipated wind and sea conditions correspond to the design category of your boat.

Always make sure your boat and your operating skills match the weather and water conditions where you are going to operate.

⚠ WARNING

Any change in the weight distribution may significantly affect the stability, trim and performance of the boat.

When loading the boat, never exceed the maximum recommended load. Always load the boat carefully and distribute loads appropriately to maintain design trim (approximately level). Avoid placing heavy weights high up.

Take into account any modifications that may affect weight distribution, such as a different engine or a fishing tower.

⚠ WARNING

Getting entrapped in the cabin and not having quick access to safety equipment can be fatal in case of flooding.

Never lock or block the access to the emergency exits or safety equipment.

Do not store luggage or other heavy items on top of the front deck hatch.

⚠ WARNING

Getting water into the hatches or inside the boat increases the risk of flooding.

Always keep hatches closed and side terraces in upright position when under way.

⚠ WARNING

Risk of flooding.

Getting water inside the boat increases the risk of flooding.

Keep seacocks closed when not needed for operation to minimize the risk of flooding (for example water inlet of toilet flushing line).

⚠ WARNING

Risk of serious injury or death.

Any leak, especially a serious one, can cause the boat to sink quickly.

Wear a life jacket at all times and evacuate immediately from a sinking boat.

⚠ WARNING

Risk of fire or explosion.

Handle open flame and fuel-driven devices with caution.

⚠ WARNING

Careless refueling is a fire hazard.

Never fill the fuel tank or handle fuel when the engine is running.

Don't smoke when handling fuel.

⚠ WARNING

Trying to cope by yourself too long can quickly escalate an emergency.
In case you cannot handle the situation, always contact rescue service without delay!

⚠ WARNING

Risk of drowning! The boat can sink or capsize if too much water gets into the boat.
Do not rely solely on the bilge pump system. It is not designed to pump out large amounts of water.

⚠ WARNING

Risk of injury.
Do not use the outboard engine's cavitation plates for reboarding.

⚠ WARNING

Risk of explosion.
Never use water to put out fuel fire. If the fire gets in touch with a flammable fuel, water can spread the fire and cause an explosion.

⚠ WARNING

Carbon monoxide (CO) is harmful to your health in higher concentrations, and can even be lethal. Even low concentrations of CO can cause damage with prolonged exposure.

Prevent the accumulation of CO in the first place by minimizing the risk situations.
Act quickly if the CO alarm turns on or if you suspect CO poisoning.

⚠ WARNING

Poor trimming can risk lives! Adjusting the trim angle at high speeds may radically affect your boat's behavior. A high running trim can obstruct the view so you may not notice swimmers and small vessels.

Avoid making adjustments at high speeds.

Don't drive with the bow high for long periods of time. Trim the boat's vertical angle to lower the attitude in congested areas.

⚠ WARNING

Overcorrecting, dropping the speed suddenly or hitting the waves at a wrong angle when driving at high speeds can have serious consequences.

Do not exceed your boating capabilities. Drive at speeds you are comfortable with.
Avoid sudden maneuvers.

Always use the lanyard stop switch.

⚠ WARNING

Risk of death, electric shock or injury.

Working on the electrical installation while the system is energized can cause an electric shock.

Never work on the electrical installation while the system is energized.

⚠ WARNING

Risk of electric shock or damage to the equipment.

Never alter or modify the rated current amperage of overcurrent protective devices.

⚠ WARNING Risk of electric shock, battery overheating, explosion, fire or harmful gases.
Do not block the battery ventilation.

⚠ WARNING Risk of electric shock, battery overheating, explosion, fire or harmful gases.
Do not use external charger on the boat.

⚠ WARNING Hot engine parts could cause a fire if in contact with flammable materials.
Store equipment that contains gasoline only in compartments designed for this purpose.

⚠ WARNING The boat can sink if too much water gets into the boat.
If you suspect a leak, find out the reason and go ashore as soon as possible. The bilge pump system is not designed to pump out large amounts of water.
If there is a rapid increase in water accumulation, call rescue service.

⚠ WARNING Risk of fire or carbon monoxide accumulation.
Do not block the heater's exhaust pipe, ventilation or warm air outlet.

⚠ WARNING Risk of fire or overheating.
Do not close the lid of the wet bar when the cooktop is hot.

⚠ WARNING Risk of death or serious injury.
Failure to lock the seat can cause you to be ejected from the seat.
Lock the cockpit seat when you drive.

⚠ WARNING Risk of injury, falling overboard or material damage.
Make sure there are no people or objects near or on the side terraces when you lower or lift them. Always lower the side terrace to the lowest locking position.
Lift the side terraces before you move the boat. It is prohibited to drive the boat unless the side terraces are locked in upright position.

⚠ WARNING A rotating propeller may cause death or a serious injury.
Shut off the engine when there are people in the water near the boat.
Do not reboard the boat when the engine is running.
Do not use the engine's cavitation plates for reboarding the boat.

⚠ WARNING

Risk of death or serious injury.

Corrosion can affect any metal component of the boat if not kept clean and dry when not in use. Deterioration from corrosion can cause component failure, leading to serious injury or death.

Always ensure that all metal components are clean and dry when the boat is not in use.

⚠ CAUTION

Risk of injury or material damage.

The owner is responsible for ensuring that the normal mode of operation is maintained. This means that the speed of the craft needs to be matched to the prevailing sea state, the craft being used with good seamanship behavior.

⚠ CAUTION

The boat may tip or the lifting straps may slide during lifting if the straps are not attached properly or if the loads move and disturb the balance of the boat.

Empty the bilge and waste water tanks and remove any unnecessary load from the boat.

Do not hook the boat through the aft wings as the straps may slide away.

⚠ CAUTION

Trailing a large load can be a traffic hazard.

Use a trailer that is suitable for the boat.

Do not exceed the trailer capacity.

Secure the boat and the trailer properly.

⚠ CAUTION

Risk of injury to people, risk of damage to your boat or other vessels.

The protruding fender cleats may collide with people or other boats when driving.

Remove the fender cleats before you drive.

⚠ CAUTION

Risk of electric shock.

Do not touch the batteries or electric connections.

⚠ CAUTION

Risk of electric shock or damage to the equipment.

Before you reset the fuse, find out why it has tripped.

⚠ CAUTION

Risk of fire, explosion or material damage.

Avoid damaging the fuel lines on your boat. Pay attention to the location and condition of the fuel lines.

⚠ CAUTION

Pollution and health hazard.

Emptying waste water tanks into the water can cause water eutrophication and visual pollution in coastal areas.

Do not empty the waste tanks into the waters where it is not allowed by the law.

Plan your voyage in a way that you can always reach shore with proper fixed waste water tanks in good time before your waste water tanks get filled.

⚠ CAUTION

Risk of injury or material damage.

Always lift the anchor up and secure it in the anchor box or lock it in the retaining system when you are not using the anchor.

⚠ CAUTION

Risk of boat tipping or side terrace breaking down, risk of people or property falling into the water.

Always remember the balance of the boat and the durability of the side terrace.

Do not allow too many people to stay on the lowered side terrace.

Do not place too much load on the lowered side terrace.

Do not exceed the maximum permitted load on the side terraces. Check the technical specification for the maximum permitted load.

⚠ CAUTION

Risk of injury or material damage.

Do not drive the boat when the sun shade is up. The sun shade and mounting poles may tear off.

Do not use the sun shade in harsh weather conditions and in strong wind.

⚠ CAUTION

Risk of injury or material damage.

Do not block access to the bathing ladder.

Do not drive the boat when the bathing ladder is down.

⚠ CAUTION

Risk of injury or material damage.

Do not use the harbor covers when driving. The covers may tear off in strong wind.

⚠ CAUTION

Risk of injury or material damage.

Chemicals and harmful gases may be dangerous to people or may cause material damage to your boat.

When using chemicals, read the manufacturer's instructions regarding safety and maintenance.

Wear protective equipment and work in a well-ventilated space.

⚠ CAUTION

Risk of injury or material damage.

Chemicals and harmful gases may be dangerous to people or may cause material damage to your boat.

Wear protective equipment when applying antifouling paint. If your paint contains solvents, work in well-ventilated space.

Make sure to read all the labels, data sheet and manufacturer’s instructions and recommendations before starting to apply antifouling paint.



Saxdor Yachts cannot be held responsible for modifications not approved by the company.

Always use trained and competent people for maintenance, repair or modifications.

Modifications that may affect the safety characteristics of the boat need to be assessed, executed and documented by competent people.

9.5 Glossary

Check here the terms and abbreviations used in the manual.

Table 9.1 - Terms and abbreviations

Term, abbreviation, acronym	Definition
ABYC	American Boat and Yacht Council
Aft, AFT	The rear of the boat
Aftdeck	Deck area in the rear part of the boat, social area
AIS	An automatic identification system (AIS) transponder which automatically provides position, identification and other information about the boat to other ships and to coastal authorities
	Aquatic Invasive Species. Plants, animals or microbes that have been classified as harmful by the ABYC if they spread from a body of water to another body of water.
ANSI	American National Standards Institute, the main organization supporting the development of technology standards in the United States
Auxiliary, Aux	Backup or supplementary equipment, such as auxiliary battery
Beaufort scale, BFT	The measure that relates wind speed to observed conditions at sea or on land
Bilge	Lowest point of the boat's inner hull
Black water	The waste water collected from the toilet.
Bow	The front end of the boat
COLREG	International regulations for preventing collisions at sea
Foredeck	Deck area at the bow of the boat

Term, abbreviation, acronym	Definition
GPS	Global positioning system
Grey water	The waste water collected from the sinks in the toilet compartment and wet bar, and from the condensate water of the air conditioning unit.
Helm station	Steering station comprising the steering and navigation equipment and the driver's seat
Hull	Boat's frame
ISO	International Standards Organization, the international standard development organization
kN	Kilonewton, unit of force
kn	Knot, a unit of speed equal to one nautical mile per hour (1 kn = 1.852 km/h or 1.151 mph)
kW	Kilowatt, unit of engine power (1 kW = 1.34 hp)
MARPOL	International Convention for the Prevention of Pollution from Ships
NMEA	National Marine Electronics Association, a combined electrical and data specification for communication between marine electronics such as echo sounder, sonars, autopilot, GPS receivers and many other types of instruments
Port	Left side of the boat when facing the bow
Starboard, STB	Right side of the boat when facing the bow
Saxdor documentation bag	A satchel including the manufacturer's manuals for the different equipment on the boat
Transom	Vertical section at the stern of the boat
Trim	The relationship of the boat's bow and stern angle to the water. Also known as attitude.
VHF	Very High Frequency radio communication system

9.6 Customer satisfaction survey

Please answer the following questions (5 = very satisfied, 1 = not satisfied at all):

	5	4	3	2	1
How satisfied are you with your new boat overall?	<input type="checkbox"/>	<input type="checkbox"/>	<input type="checkbox"/>	<input type="checkbox"/>	<input type="checkbox"/>
How satisfied are you with your new engine overall?	<input type="checkbox"/>	<input type="checkbox"/>	<input type="checkbox"/>	<input type="checkbox"/>	<input type="checkbox"/>
How satisfied are you with your dealer overall?	<input type="checkbox"/>	<input type="checkbox"/>	<input type="checkbox"/>	<input type="checkbox"/>	<input type="checkbox"/>

Other comments:

SAXDOR

ROCK THE BOAT INDUSTRY!

Contact

Saxdor Yachts Oy
Veneentekijäntie 14, 2nd floor
00210
Helsinki, Finland

www.saxdoryachts.com

hello@saxdor.com