

# SAXDOR

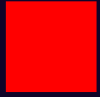

## 320 GTC

Owner's Manual

# Table of Contents

1 Welcome on board.....	6
1.1 Is this your first boat?.....	6
1.2 Your owner’s manual.....	7
1.2.1 Structure of this manual.....	7
1.2.2 Equipment manufacturers’ manuals.....	8
1.3 Copyright and disclaimer .....	8
1.4 Definitions.....	9
<b>2 Be safe.....</b>	<b>11</b>
2.1 Your responsibilities.....	11
2.2 Your safety bells and whistles on board.....	12
2.3 What is builder’s plate?.....	13
2.4 What is design category?.....	14
2.5 Avoid emergencies.....	15
2.5.1 Avoid flooding and capsizing.....	15
2.5.2 Move safely on board.....	16
2.5.3 Don't play with fire.....	16
2.5.4 Consider the carbon monoxide hazard.....	17
2.6 Help!.....	18
2.6.1 What if your boat is flooded?.....	18
2.6.2 Man overboard!.....	19
2.6.3 Fire!.....	19
2.6.4 If you suspect carbon monoxide poisoning.....	20
<b>3 You’re the captain.....</b>	<b>21</b>
3.1 Get going!.....	21
3.2 Driving and steering.....	22
3.2.1 Get to know how your boat handles.....	22
3.2.2 What is lanyard stop switch?.....	23
3.2.3 Got the attitude? About trimming your boat.....	23
3.2.4 See where you're going.....	24
3.2.5 Take it up a notch or a few.....	24
3.3 Mooring, towing and anchoring.....	25
3.4 Lifting and trailering.....	26

4 The what and where of your boat.....	28
4.1 General boat layout.....	28
4.1.1 Foredeck.....	29
4.1.2 Front cabin.....	30
4.1.3 Main cabin.....	31
4.1.4 Aft deck.....	32
4.1.5 Bathing platform.....	33
4.2 User controls.....	34
4.2.1 Helm station controls.....	35
4.2.1.1 Navigation and lighting control panel.....	36
4.2.1.2 Anchor winch control panel.....	37
4.2.1.3 Wiper control panel.....	38
4.2.2 Toilet compartment control panel.....	39
4.2.3 Side terrace control panel.....	40
4.2.4 Roof control panel.....	41
4.2.5 Fuse panel.....	42
4.2.6 Battery control panel.....	43
4.2.7 Shore power panel.....	44
4.2.8 Cooktop control panel.....	45
4.2.9 Temperature control panel.....	46
4.3 Builder's plate.....	47
4.4 Hull identification number.....	47
4.5 Safety on board.....	47
4.5.1 Safety equipment and emergency exits.....	48
4.5.2 Safe seating and moving areas.....	49
4.5.3 Safety labels on board.....	49
4.6 Hull and deck.....	55
4.6.1 Attachment points.....	56
4.6.2 Lifting points.....	57
4.6.3 Hull openings.....	58
4.6.4 Hatches.....	59
5 The how of your boat.....	61
5.1 Electrical system.....	61
5.1.1 Main switches and indicators.....	62
5.1.1.1 Switching power on and off.....	63
5.1.2 Fuses.....	63
5.1.2.1 Resetting tripped fuses.....	64

5.1.3 Batteries.....	65
5.1.3.1 Charging batteries.....	65
5.1.4 Shore power.....	66
5.1.4.1 Connecting shore power.....	66
5.1.5 Generator replacement system.....	67
5.1.5.1 Using the generator replacement system and backup power supply.....	69
5.2 Engine and steering system.....	70
5.2.1 Engine.....	70
5.2.1.1 Starting the engine.....	71
5.2.2 Trim tabs.....	71
5.2.3 Bow thruster.....	71
5.3 Fuel system.....	71
5.4 Draining system.....	73
5.4.1 Using bilge pumps.....	74
5.5 Fresh and waste water systems.....	76
5.5.1 Using the fresh water system.....	77
5.5.2 Using the toilet.....	77
5.5.3 Emptying the waste water tanks.....	77
5.6 Navigation equipment.....	79
5.7 Anchor system.....	80
5.8 Comfort and fun.....	81
5.8.1 Heating and air-conditioning.....	81
5.8.2 Wet bar.....	82
5.8.3 Seating.....	83
5.8.4 Side terraces.....	84
5.8.4.1 Using the side terraces.....	85
5.8.5 Sun shade.....	86
5.8.6 Water ski pole.....	86
5.8.7 Bathing ladder.....	87
5.8.8 Harbor covers.....	87
5.8.9 Lighting and audio.....	87
<b>6 Respect the environment.....</b>	<b>89</b>
6.1 Handling waste properly.....	89
6.2 Avoiding contaminant spills.....	89
6.3 Minimizing emissions and disturbance.....	89
6.4 Preventing the spreading of aquatic invasive species.....	90
<b>7 Care for your boat.....</b>	<b>91</b>

---

8 The details.....	92
8.1 Technical specification.....	92
8.2 Boat dimensions.....	94
9 Extras.....	97
9.1 Declaration of conformity.....	97
9.2 Electrical wiring diagram.....	97
9.3 Warranty.....	97
9.4 Warnings and cautions.....	97
9.5 Glossary.....	104
9.6 Customer satisfaction survey.....	106

# 1 Welcome on board

Congratulations on the purchase of your new Saxdor yacht - the best decision ever made!

Saxdor Yachts welcomes you to the new era of boating! Your Saxdor yacht is built to the highest standards for your pleasure with cutting-edge technologies and attention to safety. Enjoy your new boat's amazing design and high functionality coupled with excellent driving.

This manual is your buddy — not something you stow in the furthest corner of your boat. It contains, together with the equipment manufacturers' manuals, essential information you will need to operate your boat in a safe and enjoyable way. It includes detailed information about the boat and its equipment and accessories, as well as instructions for use and correct maintenance of the boat. Please read the manual carefully and familiarise yourself with your boat before using it.

However, this owner's manual alone is not meant to be a sufficient source of information on safe boating and seamanship. If this is your first boat or if the boat type is not familiar to you, please make sure you obtain sufficient training and experience in handling and using the boat before heading out.

If you sell your boat, please make sure to pass this manual, along with the equipment manufacturers' manuals, on to the new owner.

For more details, see section [1.2 Your owner's manual](#) on page 7.

## 1.1 Is this your first boat?

We are really happy to welcome you on board as a captain of your first boat — and that being a Saxdor! Let's get you introduced to some important information so your boat can serve you well on every journey, and both you and the boat remain safe and well taken care of at all times.

- Safety first

We cannot emphasize the importance of safety enough. If you're new to the addictive joy of being a captain, please take the time to carefully read sections [2 Be safe on page 11](#) and [3 You're the captain on page 21](#). Although your boat is built to the highest safety standards, it is important that you understand the safety aspects of seamanship and have the necessary skills that allow you to enjoy your yacht to the fullest.

- Consider a boating course

If you are new to the world of seafaring, a course on boating safety and seamanship can help you get the right introduction and a feeling of confidence. Your Saxdor dealer or boating society will be able to guide you on this.

- You may need a driver's licence

Some countries require that you have a licence to operate your boat. There may also be specific regulations and carriage requirements in place. Your Saxdor dealer will know about the requirements in your own country.

- Insurance is a good idea, even if not required by law

Insurance can cover for any damage that may occur whenever the boat is being transported and stored, and in use.

Your Saxdor dealer and/or local authorities can provide you with information about insurance requirements in your area. You can also contact insurance companies directly for information on the various alternatives available.

- Registration

In some regions it may be mandatory to register boats of your boat type. Operating the boat may also be subject to holding a license or other qualification. In addition, minimum age requirements may apply.

If unsure, check with your Saxdor dealer.

## 1.2 Your owner's manual

Learn more about the contents and availability of the user documentation.

The latest version of your manual is always available in the Saxdor share portal. You can check for updated versions for your model year at [manuals.saxdoryachts.com](https://manuals.saxdoryachts.com).



This manual describes all the options available for this boat model. The configuration on your boat may vary depending on the equipment you have selected, and some of the options may not be available in your region.

The equipment manufacturers' manuals complement this owner's manual. They are included in the Saxdor documentation bag that comes with your purchase.

In case of any difficulties, contact your Saxdor dealer representative for advice and assistance. Saxdor contact information is available at [www.saxdoryachts.com](https://www.saxdoryachts.com).

### 1.2.1 Structure of this manual

The information you will find in the following sections of this manual is organized as follows.

- Be safe

A guide on the steps you need to take to ensure you, your crew, and your guests remain safe at all times whenever on board.

- You're the captain

Get to know how your boat operates, and take control. This manual is, however, not a course on seamanship or boating safety. For the comfort and safety of both yourself and your crew and guests, please ensure you take a boating and seamanship course, or otherwise gain the handling and operating experience you need, before taking the boat out to sea.

- The what and where of your boat

This section is a graphical presentation of the contents of your boat. See the overall layout and positions of equipment on board at a glance, and discover the different components and control functions in detail.

- The how of your boat

Learn how the systems on your boat work. While this section does give some instructions on how to operate the boat, it doesn't provide full step-by-step instructions on the equipment on board. For these, you need to consult the equipment manufacturers' own manuals.

- Respect the environment

What you can do to keep other persons, the sea and mother nature from harm.

- Care for your boat

This section will give you some guidelines on how to best take care of your boat to ensure a long lifespan and maximum pleasure, but it is not a detailed maintenance guide. Consult the equipment manufacturers' manuals for more detailed instructions. We advise you to always turn to a professional service for the maintenance of your boat.

- When in trouble

Some tips for simple troubleshooting.

- The details

All the technical specifications and the dimensions of your boat.

- Extras

Appendices. Links to the full warranty card, wiring diagrams, and equipment manufacturers' websites. Also a glossary of some important terms, and a summary of warnings and cautions that occur in this manual.

## 1.2.2 Equipment manufacturers' manuals

The Saxdor documentation bag includes a hard copy of the manuals or quick guides of the equipment that you have selected for your boat.

In case of missing documents please contact your local Saxdor dealer for replacement documents.

## 1.3 Copyright and disclaimer

### Property rights / Copyrights

1. The information included in this document remains the exclusive property of Saxdor Yachts Ltd (hereinafter "Saxdor")
2. Under this document, or in any other act that has been performed in the process of the purchase of the Saxdor boat (hereinafter "Product"), Saxdor does not convey licenses or other rights of any kind, including but not limited to, rights to know-how, patents, utility models, designs, copyrights or other industrial property rights or titles, be it expressed, implied or tacitly.
3. Except for the right to utilize the Product and this document, the issuance of the document does not constitute an express or implied grant to any rights to or under Saxdor's patents, copyrights, trade secrets, trademarks or other intellectual property rights. The owner/recipient of this manual and of the Product (hereinafter "User") will not use any tradename, trademark, logo or any other proprietary rights



of Saxdor or any of its affiliates in any manner without a prior written authorization of such use by a duly authorized representative of Saxdor.

4. The User is prohibited from registering his/hers own industrial property rights, such as patents, registered design or utility models, on the basis of the information obtained or received with this document or in connection with the Product purchase, as well as otherwise exploit the information included in this document for commercial gain.

### Disclaimer

1. This document is provided "as is". The information in this document is believed to be accurate and reliable. However, Saxdor is not responsible for the content of this document, insofar as legally permissible, and makes no representations or warranties, express or implied, as to the accuracy or completeness of such information and shall not be liable for the consequences of the use of the information included.
2. This document, unless explicitly otherwise indicated, does not include any implied warranties of satisfactory quality, merchantability, fitness for a particular purpose, compatibility or non-infringement.
3. Saxdor reserves the right to make changes to the information published in this document, including without limitation specifications and product descriptions, at any time and without notice.
4. This document supersedes and replaces all information supplied prior to the publication hereof.
5. Saxdor products are not designed, authorized or warranted to be suitable for applications where failure or malfunction could result in personal injury, death, or serious property or environmental damage. Saxdor is not responsible for the incorporation and/or use of its products in such situations or applications, and therefore, such inclusion and/or use is at the User's own risk.
6. Neither Saxdor nor anyone else who has been involved in the creation, production or delivery of the Product shall be liable for any special, indirect, consequential, incidental or punitive damages (including, but not limited to, lost revenues, profits and/or savings) arising from reasonably improper use or inability to use the Product, even if Saxdor has been informed of the possibility of such damages or claims.

## 1.4 Definitions

See here the conventions used in this manual.

### Measurement units

Measurement units are, in general, given in accordance with the International System of Units (SI) and the United States Customary Units (USCS). USCS units used in this manual has been calculated from the original SI units. Exceptions:

- Wind force is given in the Beaufort scale (BFT)
- Speed is given in knots (kn).

### Figures

All figures are shown for illustration purposes only. Actual product may vary depending on the selected optional features and equipment.

- Details framed in solid red line illustrate areas and equipment locations on your boat.
- Details framed in dotted red line refer to areas or equipment which are inside your boat or not directly visible in the figure.
- Green arrows indicate emergency exits.

- Filled orange circles refer to designated passenger seats.
- Filled orange area with diagonal lines illustrates the working deck area.

### Safety symbols

Warnings and cautions are labeled in accordance with the international ISO and ANSI standards.

#### **DANGER**

Indicates an imminently hazardous situation which, if not avoided, will result in death or serious injury.

#### **WARNING**

Indicates a potentially hazardous situation which, if not avoided, could result in death or serious injury.

#### **CAUTION**

Indicates a potentially hazardous situation which, if not avoided, may result in minor or moderate injury.

#### **NOTICE**

Indicates a potential situation which, if not avoided, may result in property damage or in an undesirable result or state.



Gives additional information or calls for attention to the correct use of the product, to the expectations of the user, or to how to avoid error situations.

## 2 Be safe

A guide on the steps you need to take to ensure you, your crew, and your guests remain safe at all times whenever on board.

### 2.1 Your responsibilities

Safety is the first step and most important step towards getting maximum pleasure out of your boat. Please familiarize yourself with the contents of this chapter before taking your boat out to sea for the first time.

As the captain of your boat, you have the ultimate responsibility! Not just for yourself, but also for your crew, any guests on board and other seafarers.

#### **⚠ WARNING**

Risk of collision.

Do not operate the boat outside of inland waterways in foggy conditions, in poor visibility or at night.

#### **⚠ WARNING**

Neglecting the necessary safety precautions can risk lives.

Take safety seriously. Remember that you as the driver are responsible for the safety for others.

#### **⚠ CAUTION**

Risk of injury or material damage.

The owner is responsible for ensuring that the normal mode of operation is maintained. This means that the speed of the craft needs to be matched to the prevailing sea state, the craft being used with good seamanship behavior.

#### **Behave responsibly!**

- Make sure you and any other persons who will operate your boat have the necessary boating and navigation skills.
- Check that all persons on board, yourself inclusive, are wearing a life jacket at all times.
- Do not let anyone swim around the boat when the engine is running.
- Load the boat correctly within capacity limits.
- Don't drink and drive.
- Do not climb on the roof or use the engine as a stepping platform.
- Be aware of and make sure you comply with all applicable local laws and regulations.
- Make sure the safety equipment complies with local regulations.

- Take good care of your boat and have it serviced regularly. Don't attempt to perform any major repairs by yourself or make modifications to your boat without consulting your Saxdor dealer first.
- Read this manual and the documentation supplied in the Saxdor documentation bag and heed the warnings and cautions in them.

### Be prepared!

- Know your boat and understand the safety limitations set on your boat by capacity and design category.
- Proactively maintain your boat to keep it in good condition. Keep an eye on any signs of wear and tear and have them repaired immediately.
- Familiarize yourself with the location of all safety equipment on board, and check that they are fully functional before setting off.
- Make sure you understand all emergency procedures.
- Also make sure that everyone on board is familiar with the correct use and operation of all safety equipment in the event of an emergency.
- Check the weather conditions and forecast before you set off.
- Plan your route and stopovers, and make sure you have the equipment and facilities needed.
- Make sure you are familiar with local laws and regulations concerning reporting accidents.

### Be aware of risks and know how to act

Boating always comes with certain risks. Make sure you know how to minimize these risks, and be prepared to act in the event something were to happen.

### Learn more

- How to be prepared: [2.5 Avoid emergencies](#) on page 15
- How to act in case of emergency: [2.6 Help!](#) on page 18

## 2.2 Your safety bells and whistles on board

To ensure carefree and safe boating, your boat is equipped with different safety fixtures. Familiarize yourself with them before setting off on your voyage for the first time.



There maybe different or additional requirements for safety equipment in your country. In some countries it is a legal requirement to wear a life jacket.

This kind of additional safety equipment is not Saxdor's responsibility. Also, it is your responsibility to ensure that the equipment complies with local regulations and that these devices are fully functional. If unsure, consult your Saxdor dealer.

### Builder's plate

Start with the builder's plate! It contains important safety information, such as maximum load and number of people, which you must abide by at all times.

## Safety equipment and emergency exits

Your boat comes with emergency exits, a CO detector and space reserved for additional safety equipment. Your Saxdor dealer will help you get the additional safety equipment required in your country, such as fire extinguishers and smoke detectors.

Before setting off, make sure:

- All safety equipment is fully functional and easily accessible.
- Everyone on board knows where to find the safety equipment and emergency exits.
- Everyone knows how to use the equipment and how to act in an emergency.
- Everyone wears a life jacket, even if not required by law.

Maintain your safety equipment

- Have the fire extinguisher inspected at the intervals indicated on the device or according to the local legislation. Replace the fire extinguisher if it has been expired.

### **WARNING**

Risk of fire or explosion.

When replacing parts of the fire-fighting installation only matching components shall be used, bearing the same designation or being equivalent in their technical and fire resistant capabilities.

- Test the operation of smoke and CO detectors according to the local legislation.

## Safety labels

Your boat is equipped with labels containing important safety information. Make sure:

- You and everyone on board understands the meaning of the safety symbols and the texts on the labels.
- Everyone obeys the instructions on the labels.

## Related information

[4.3 Builder's plate](#) on page 47

[4.5.1 Safety equipment and emergency exits](#) on page 48

[4.5.3 Safety labels on board](#) on page 49

## 2.3 What is builder's plate?

The builder's plate is an ISO certification label and proof of the consistent, high standard of Saxdor yachts.

The builder's plate on your boat is located close to the steering wheel and contains important safety information such as:

- Your boat's design category
- Load capacity (not including fuel)
- Maximum permitted number of persons, engine weight and power

The plate also shows the boat builder's contact details.

**⚠ WARNING**

Not heeding the limitations on the builder's plate can put you and your passengers at risk. Do not exceed the maximum permitted engine power or number of persons on board. Respect the conditions set out by the design category of your boat.

**Related information**

[4.3 Builder's plate](#) on page 47

## 2.4 What is design category?

Design category is an important element of safe boating! It defines the weather and nautical conditions in which it is safe to operate your boat.

**⚠ WARNING**

Not respecting the design category limitations of your boat can put you and your passengers at risk.

Do not exceed the maximum permitted engine power or number of persons on board.

Ensure that the anticipated wind and sea conditions correspond to the design category of your boat.

Always make sure your boat and your operating skills match the weather and water conditions where you are going to operate.

Design category conditions are specified using maximum wind speed and maximum significant wave height as measurement. A significant wave height refers to the average height of the highest one third of all waves, visually estimated.

For example, design category C conditions are typically encountered in exposed inland waters, estuaries and coastal areas in moderate weather conditions. Design category B conditions are more severe — typically encountered offshore, but also in coastal areas and larger inland waters where sheltered areas are not readily available.

*Table 2.1 - Design category specification*

Description	Category A		Category B		Category C		Category D	
Wind force	Beaufort force exceeding 8		Beaufort force 8 or less		Beaufort force 6 or less		Beaufort force 4 or less	
Significant wave height	>4 m	>13 ft	≤4 m	≤13 ft	≤2 m	≤6.6 ft	≤0.3 m	≤1 ft

### What is my boat's design category?

Your boat's design category is indicated on the builder's plate. You can also check it from the Technical specification in this manual.



Be aware that your boat can be used in different conditions depending on the number of people on board. So please make sure you follow the safety rules, for example:

- For category C conditions, you can have the maximum number of passengers indicated on the builder's plate on board.
- If you venture out to waters with design category C conditions, you must restrict the number of passengers to the lower limit on the builder's plate.

## 2.5 Avoid emergencies

Know what the risks are, act responsibly, and have a plan.

### 2.5.1 Avoid flooding and capsizing

Don't compromise stability!

Do not worry! Your boat is designed to be very stable and does not get easily flooded.

Also, remember that when boating, it is normal to get water into the boat. To keep your feet nice and dry, and the boat afloat, there are several drainage openings in the hull. Automatic bilge pumps work non-stop to keep the bilge clear of water. A manual pump complements the automatic pump.

However, stability can be compromised by many things such as rough waters, towing, poorly balanced load and too much water in the bilge. Take these steps to maximize stability:



#### 1. Load your boat right.

- Respect the design category limitations on the number of persons on board.
- Make sure everybody on board is seated in the designated seats.
- Do not exceed the maximum allowed load on the builder's plate.
- Make sure all equipment, accessories and luggage items are stowed and will stay securely in place even in rough sea conditions and strong winds.

#### **WARNING**

Any change in the weight distribution may significantly affect the stability, trim and performance of the boat.

When loading the boat, never exceed the maximum recommended load. Always load the boat carefully and distribute loads appropriately to maintain design trim (approximately level). Avoid placing heavy weights high up.

Take into account any modifications that may affect weight distribution, such as a different engine or a fishing tower.

#### **WARNING**

Getting entrapped in the cabin and not having quick access to safety equipment can be fatal in case of flooding.

Never lock or block the access to the emergency exits or safety equipment.

Do not store luggage or other heavy items on top of the front deck hatch.

2. Close side terraces, doors and hatches while under way.
  - Always lock the side terraces in upright position before you set off.
  - Always keep all hatches and storage locker lids closed while under way.
  - Keep portlights, windows, washboards, doors and ventilation openings closed in rough weather or at planing speed.

**⚠ WARNING**

Getting water into the hatches or inside the boat increases the risk of flooding.

Always keep hatches closed and side terraces in upright position when under way.

3. Keep the drain outlets functional and monitor water levels.
  - Always keep the drain holes open. The only time you may close them is in a situation where water starts getting into boat during loading.
  - Clear the pump inlets from debris if needed.
  - If the seacocks are fitted in the front and aft peak bulkheads, keep them closed. You may only open them in order to let water drain into the main bilges.
  - If you notice that there is more water than usual in the bilge, or if you get the high bilge water alarm, check your boat for leaks and damage to the hull. Use the manual bilge pump to pump out the excess water.

**⚠ WARNING**

Getting water inside the boat increases the risk of flooding.

Keep seacocks closed when not needed for operation to minimize the risk of flooding (for example water inlet of toilet flushing line).

## 2.5.2 Move safely on board

To ensure your safety, your boat has designated areas for moving on board and sitting while using the boat.

- Use the working deck area when mooring and leaving the shore.
- Ensure that everyone on board is seated in the designated seating areas during voyage. Do not exceed the maximum allowed number of persons on board.



### Related information

[4.5.2 Safe seating and moving areas](#) on page 49

## 2.5.3 Don't play with fire

Avoid situations that can cause a risk of fire.

Make sure you are familiar with the location of safety equipment and emergency exits on board.



**⚠ WARNING** Risk of fire or explosion.  
Handle open flame and fuel-driven devices with caution.

**⚠ WARNING** Careless refueling is a fire hazard.  
Never fill the fuel tank or handle fuel when the engine is running.  
Don't smoke when handling fuel.

To minimize the risk of fire, always take these safety measures:



- Be careful not to damage fuel lines.
- Never store fuel containers or equipment containing fuel in any area not designated for the purpose.
- Never obstruct access to the fuel tank compartment, safety controls, electrical systems, ventilation units, safety equipment or passageways to fire exits and hatches.
- Don't make changes to your boat's electrical, ventilation or fuel systems yourself.
- Never leave the stove or heater unattended or have any free hanging curtains or other fabrics near them.
- Check the bilge regularly to make sure that there are no fuel leaks.
- When replacing safety equipment, make sure it complies with local requirements.

**⚠ WARNING** Risk of fire or explosion.  
When replacing parts of the fire-fighting installation only matching components shall be used, bearing the same designation or being equivalent in their technical and fire resistant capabilities.

### Related information

[4.5.1 Safety equipment and emergency exits](#) on page 48

## 2.5.4 Consider the carbon monoxide hazard

Carbon monoxide (CO) is an odorless but potentially lethal gas! Be aware of and avoid situations in which there is a risk of CO accumulation.

**⚠ WARNING** Carbon monoxide (CO) is harmful to your health in higher concentrations, and can even be lethal. Even low concentrations of CO can cause damage with prolonged exposure.  
Prevent the accumulation of CO in the first place by minimizing the risk situations.  
Act quickly if the CO alarm turns on or if you suspect CO poisoning.

Engine exhausts contain carbon monoxide (CO). High CO concentrations can occur especially when:

- Running the engine in confined spaces in a standstill, for example with the boat close to another vessel or with the engine next to a wall.
- Driving at slow speeds or in a tailwind.
- Driving with the bow high.
- Running the engine with the cabin door open may cause exhaust fumes to enter the cabin.

To prevent CO accumulation:



- Do not rev or idle the engine unnecessarily, for example when mooring or when there are persons in the water.
- Do not block exhaust outlets and inspect the exhaust system regularly.
- Ensure all areas on the boat are kept well ventilated if you're using a diesel heater or any other fuel-burning device.
- Keep the cabin door closed when running the engine.
- Leave enough space between the engine and any obstacle.

### Related information

[2.6.4 If you suspect carbon monoxide poisoning on page 20](#)

## 2.6 Help!

Even though you try to avoid it - emergencies do occur. Being prepared and knowing how to act is the best way to prevent them from getting serious.

### **WARNING**

Trying to cope by yourself too long can quickly escalate an emergency.

In case you cannot handle the situation, always contact rescue service without delay!

### 2.6.1 What if your boat is flooded?

When boating, it is normal to get some water into the boat. However, if water starts to accumulate, you need to take action.

### **WARNING**

Risk of drowning! The boat can sink or capsize if too much water gets into the boat.

Do not rely solely on the bilge pump system. It is not designed to pump out large amounts of water.



- If you suspect a leak, act quickly.
  - If there is a rapid increase in water accumulation, call rescue service.
  - If you have moderate accumulation of water, reduce the flooding manually. Use the manual pump or a bail.

- Make sure everyone is wearing a life jacket.
- Find out the reason and go ashore as soon as possible.

#### Related information

[2.5.1 Avoid flooding and capsizing on page 15](#)

[4.5.1 Safety equipment and emergency exits on page 48](#)

[5.4 Draining system on page 73](#)

## 2.6.2 Man overboard!

If a person has fallen into the water.



- Point the boat directly into the wind.
- Stop the engine if it is running.
- Hand the person a flotation device if they are not wearing one.
- Help the person back on board. You can lower the bathing ladder for the purpose.



#### **WARNING**

Risk of injury.

Do not use the outboard engine's cavitation plates for reboarding.

#### Related information

[4.1.5 Bathing platform on page 33](#)

[5.8.7 Bathing ladder on page 87](#)

## 2.6.3 Fire!

Don't waste time!



- Turn off power from all the power sources.
- Close the fuel valve.
- Check that everyone is wearing a life jacket.
- Use a fire blanket or fire extinguisher to put out the fire. Do not use water!



#### **WARNING**

Risk of explosion.

Never use water to put out fuel fire. If the fire gets in touch with a flammable fuel, water can spread the fire and cause an explosion.

- Don't hesitate to call for help and evacuate the boat if the fire starts spreading.

## 2.6.4 If you suspect carbon monoxide poisoning

If a person has been exposed to carbon monoxide, act quickly!

**⚠ WARNING**

Carbon monoxide (CO) is harmful to your health in higher concentrations, and can even be lethal. Even low concentrations of CO can cause damage with prolonged exposure.

Prevent the accumulation of CO in the first place by minimizing the risk situations.

Act quickly if the CO alarm turns on or if you suspect CO poisoning.



- If the CO alarm turns on:
  - Turn off the engine(s) and all possible devices.
  - Do not use fire or any electronics.
  - Open all the ventilation hatches and doors.
- If a person shows signs of CO poisoning (headache, dizziness, ringing in the ears, nausea, loss of consciousness):
  - Move the person to a well ventilated area and have them breathe fresh air deeply.
  - If breathing has stopped, call rescue service and resuscitate!

## 3 You're the captain

In this section of the manual we will help you understand how to operate a boat and how to take control.

This manual is, however, not a course on seamanship or boating safety. For the comfort and safety of both yourself and your crew and guests, please ensure you take a boating and seamanship course, or otherwise gain the handling and operating experience you need, before taking the boat out to sea.

### 3.1 Get going!

You're raring to go, and so is your boat! But before you set off, ensure that you've gone through all the relevant checks.

- Check the weather forecast. Consider the prevailing wind force, wave profile and visibility. Don't exceed the capabilities of your boat's design category.
- Make sure you and your crew have the necessary boating and navigation skills. Agree on the duties for each person before approaching and leaving the shore.
- Make sure you load your boat right. Ensure that your load, including the number of passengers, does not exceed the maximum limit of your design category.
- Check you have all the necessary equipment such as life jackets for all passengers, mooring lines, fenders, functional safety equipment and a compass. Have a print copy of your charts covering a sufficiently large area.
- Refuel the boat and make sure you use the right type of fuel. Check the engine manual, if in doubt.
- Inspect the engine as specified in the engine manual.
- Be prepared for unexpected situations with extra fuel and provisions. Not to forget spare batteries for equipment like phones and flashlight.
- Check that all the critical equipment such as the steering system, navigation lights, horn and bilge pumps are functional.
- Check that the drain seacocks are open, other seacocks closed, hatches closed, and bilge clear of water and fuel.
- Ensure sufficient ventilation of the fuel compartments to reduce the risk of fire. Make sure ventilation channels are unobstructed.
- Make sure you know and obey the right-of-way rule and other navigation rules defined in the International Regulations for Preventing Collisions at sea (COLREG).



When filling the fuel and fresh water tanks, remember that you may not be able to fill up the tanks all the way if the boat is not level due to the trim or an uneven load trim. Therefore, always keep an extra 20% reserve.

#### Related information

[2.1 Your responsibilities](#) on page 11

[2.4 What is design category? on page 14](#)

[2.5.1 Avoid flooding and capsizing on page 15](#)

## 3.2 Driving and steering

All aboard? Check out these tips and get cruising!

### 3.2.1 Get to know how your boat handles

Your boat has its own unique behavior. Learn to know her before entering crowded waters or docks.

#### Maneuvering the boat

- First practice controlling your boat in open and protected water with enough space.
- Learn how your boat responds to wind, waves and currents from different directions.
- Avoid sudden maneuvers at speed.
- Always be certain you have sufficient distance to stop or maneuver if required to avoid collisions.
- When approaching or leaving the shore, apply the throttle in sharp and short doses to make your steering maneuvers efficient. Avoid sudden steering movements and make sure that all crew members not required to assist in the docking remain seated.
- Practice trimming until you are comfortable using it.
- If you have a twin engine model, practice docking and other behaviors specific to twin engines.
- If you are the driver and must leave the helm station, make sure to shift the engine into neutral.

#### Using the engine throttle and shift control

- Start the engine(s) and attach the lanyard stop switch cord to yourself.
- Shift to forward or reverse as necessary to get out of the dock.
- When you leave the dock, maneuver and gradually add speed as necessary.
- Always stop at the neutral position and allow the engine idle speed to stabilize before you shift into another gear. Shift into gear with a quick motion.
- Push the control handle gently forward or back until you reach the desired speed.
- Gently pull the control handle back to neutral position when you want to slow down.
- Learn how to trim the boat with the throttle and shift control.

#### **NOTICE**

Risk of severe engine damage! Shifting the engine into reverse at forward speeds higher than idling speed could cause the engine to stall and allow water to enter the engine's cylinders.

Drop the speed to idling speed before you shift into reverse.

## Related information

[3.2.3 Got the attitude? About trimming your boat](#) on page 23

[3.2.5 Take it up a notch or a few](#) on page 24

[5.2.1.1 Starting the engine](#) on page 71

## 3.2.2 What is lanyard stop switch?

Don't want your boat to ride without a driver? The lanyard stop switch comes to the rescue.

The lanyard stop switch shuts down the engine if the driver moves too far from the helm station, or falls overboard. The switch with the lanyard is located at the helm station.



The switch doesn't work if the driver is not hooked onto it!

- Always attach the lanyard to yourself immediately after having released the mooring lines.
- Don't forget to release the lanyard when docking so that the engine doesn't stop unintentionally.

Check the engine manufacturer's manual for more details about using the lanyard stop switch.



You may have an option for a wireless lanyard stop switch. If you have this feature, you may use it instead of the fixed lanyard stop switch.

## Related information

[4.2.1 Helm station controls](#) on page 35

## 3.2.3 Got the attitude? About trimming your boat

Learn how to trim your boat in order to ensure a smooth cruise and optimal performance.

The trim, or attitude, of your boat is its running angle as it makes way in the water. Running in the wrong trim angle gives you a bumpy ride and loads the engine unnecessarily. Learn how to:

- Adjust the boat's vertical running angle (raise or lower the bow) when getting to planing speed or changing speeds.
- Play with your trim until you find the most comfortable ride while cruising.
- Adjust the boat's heel (lateral angle) when travelling in a crosswind or with an unbalanced load.

You can trim your boat from the trim tabs control at the helm station. By using the trim tabs you can adjust:

- The boat's vertical running angle.
- The boat's heel.

You can also trim your boat's vertical angle using the engine throttle and shift control. Trimming changes the propeller shaft angle, which causes the bow to move up or down.

**⚠ WARNING**

Poor trimming can risk lives! Adjusting the trim angle at high speeds may radically affect your boat's behavior. A high running trim can obstruct the view so you may not notice swimmers and small vessels.

Avoid making adjustments at high speeds.

Don't drive with the bow high for long periods of time. Trim the boat's vertical angle to lower the attitude in congested areas.

See the trim tab manufacturer's manual for detailed instructions on how to use the trim tabs.

See also the engine manufacturer's manual.

**Related information**

[4.2.1 Helm station controls](#) on page 35

[5.2 Engine and steering system](#) on page 70

### 3.2.4 See where you're going

To avoid any unexpected dangerous situations, ensure you are always able to see where you are going and what is happening around your boat.

- Make sure nobody or nothing is blocking the view from the helm station.
- Be aware that a high running trim can obstruct the view so you may not notice swimmers and small vessels. Don't drive with the bow high for long periods of time and trim the boat to lower the attitude in congested areas.
- Turn on the navigation lights when it is dark or the visibility is poor.
- Find out beforehand how the windshield wiper works.

### 3.2.5 Take it up a notch or a few

Despite your Saxdor boat's wow performance, you will resist the urge to show off driving at full speed — being the responsible person you are.



**⚠ WARNING**

Overcorrecting, dropping the speed suddenly or hitting the waves at a wrong angle when driving at high speeds can have serious consequences.

Do not exceed your boating capabilities. Drive at speeds you are comfortable with. Avoid sudden maneuvers.

Always use the lanyard stop switch.

**Respect the boat's and your own limits**

- The faster you drive your boat, the less of it is connected to the water, and this means the boat feels more responsive to even your small adjustments. At high speed you have less control over your boat at the beginning of a turn.
- Be careful with trimming at high speeds. Don't drive with the bow down.
- When driving in planing mode the boat lifts off the water surface and the air draft increases. Reduce speed when driving under low obstacles such as bridges.
- Do not drive at maximum speed while in congested high traffic waterways, high winds, large waves or when visibility is reduced.
- Do not exceed the maximum recommended engine power shown on the builder's plate and in Technical specifications.
- Secure loose equipment safely when underway.

**Be considerate**

- Reduce your speed and wake as a courtesy and as a safety consideration to yourself and others.
- Observe and obey the speed limits.
- Respect no wake zones to protect the environment.

## 3.3 Mooring, towing and anchoring

Check here for tips about mooring, towing and anchoring.

**Practice the techniques**

- Practice mooring in calm weather, and use large enough fenders.
- Always tow or be towed at a slow speed. Never exceed the hull speed of a displacement boat when being towed.
- When anchoring, make sure you anchor far enough from the shore, and a sufficiently long rope to get a good hold.
- Always lift and secure the anchor when you are not using it.

**Strong points for attachment**

Your boat has several cleats to be used as strong points for mooring, towing and anchoring.

- When you tow another boat, use the aft cleats.
- When your boat is towed, use the bow cleats.



Some boat models have a separate towing plate in the bow, which you can also use for towing your boat.

- Always use at least two cleats and big enough fenders when mooring at a dock to prevent the boat from moving and scraping against other boats or structures onshore.
- Do not exceed the breaking strength of the strong points. See Technical specification for details.

### Mooring, anchoring and towing lines

- Ensure that mooring lines, towing lines, anchor chains, anchor lines and anchors are adequate for the boat's intended use. The lines or chains must not exceed 80 % of the breaking strength of the respective strong point. Preferably, use the towing and mooring lines provided in the mooring package of your boat. If you are unsure what kind of equipment to use, contact your Saxdor dealer.
- Always attach the lines so that they can be released when under load.
- Make sure your mooring lines and fenders are ready at hand for docking.
- Make sure the lines and chains don't get tangled in the propeller.

### Related information

[4.2.1.2 Anchor winch control panel](#) on page 37

[4.6.1 Attachment points](#) on page 56

[5.7 Anchor system](#) on page 80

## 3.4 Lifting and trailering

Treat your boat well even on land.

You and your boat would rather be on the water, but sometimes you need to lift and transport your boat for maintenance, out-of-the-season storage, or to another location.

It is recommended you use a professional service, unless you're skilled enough and have the right type of equipment for the task.

### Lifting

#### CAUTION

The boat may tip or the lifting straps may slide during lifting if the straps are not attached properly or if the loads move and disturb the balance of the boat.

Empty the bilge and waste water tanks and remove any unnecessary load from the boat.

Do not hook the boat through the aft wings as the straps may slide away.

- Lift the boat only from the recommended lifting points.
- Always use spreader bars when lifting the boat. They distribute the weight of the boat over the two lifting points. Make sure the spreader bars are long enough to protect the hull and side terraces from damage.

## Trailing

**⚠ CAUTION** Trailering a large load can be a traffic hazard.

Use a trailer that is suitable for the boat.

Do not exceed the trailer capacity.

Secure the boat and the trailer properly.

- Make sure to remain within the limits of the maximum mass indicated in Technical specification ( $m_T$ ).
- Make sure your vehicle is powerful enough and you know how to maneuver the trailer.
- Use the cleats in the bow of your boat to pull your boat onto a trailer.
- Attach the boat to the trailer from all cleats of your boat.

## Related information

[4.6.2 Lifting points](#) on page 57

## 4 The what and where of your boat

Here you can see the overall layout, the equipment and the features of your boat in pictures.



The following images describe the options available for this boat model. The configuration on your boat may vary depending on the equipment you have selected, and some of the options may not be available in your region.

### 4.1 General boat layout

Get an overview of the general layout of your boat and become familiar with the different compartments.

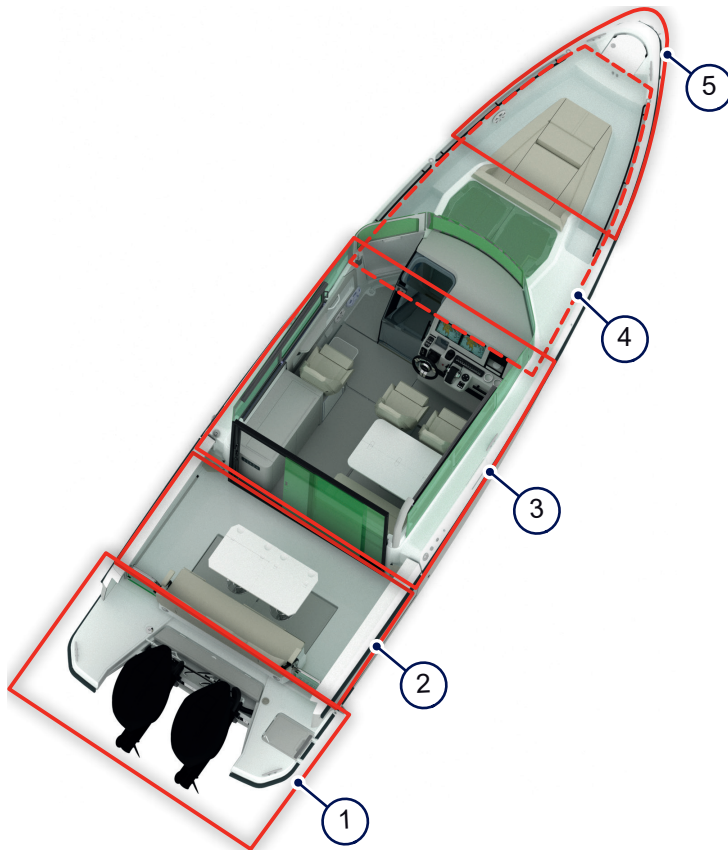

Figure 4.1 - General boat layout

- |   |                  |   |             |
|---|------------------|---|-------------|
| 1 | Bathing platform | 4 | Front cabin |
| 2 | Aft deck         | 5 | Foredeck    |
| 3 | Main cabin       |   |             |

### 4.1.1 Foredeck

See here what you can find on the foredeck.

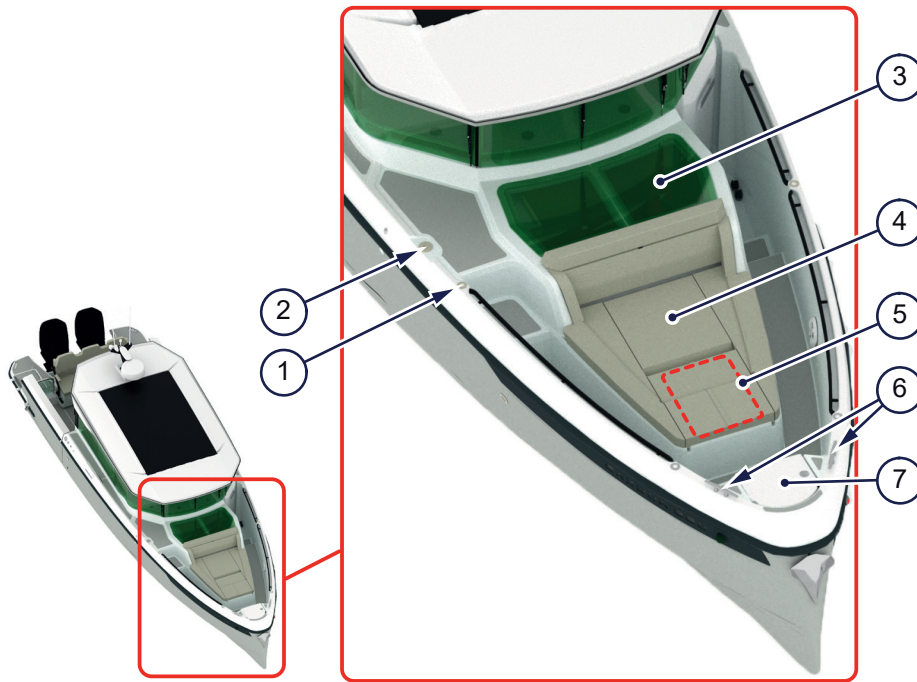

Figure 4.2 - Foredeck

- |   |   |   |                                      |
|---|---|---|--------------------------------------|
| 1 | Sun shade mounting (both sides of the boat) | 5 | Foredeck hatch, under the sun bed    |
| 2 | Black water discharge outlet                | 6 | Cleats for mooring and getting towed |
| 3 | Front cabin skylight                        | 7 | Anchor box hatch                     |
| 4 | Sun bed                                     |   |                                      |

## 4.1.2 Front cabin

See here what you can find in the front cabin.

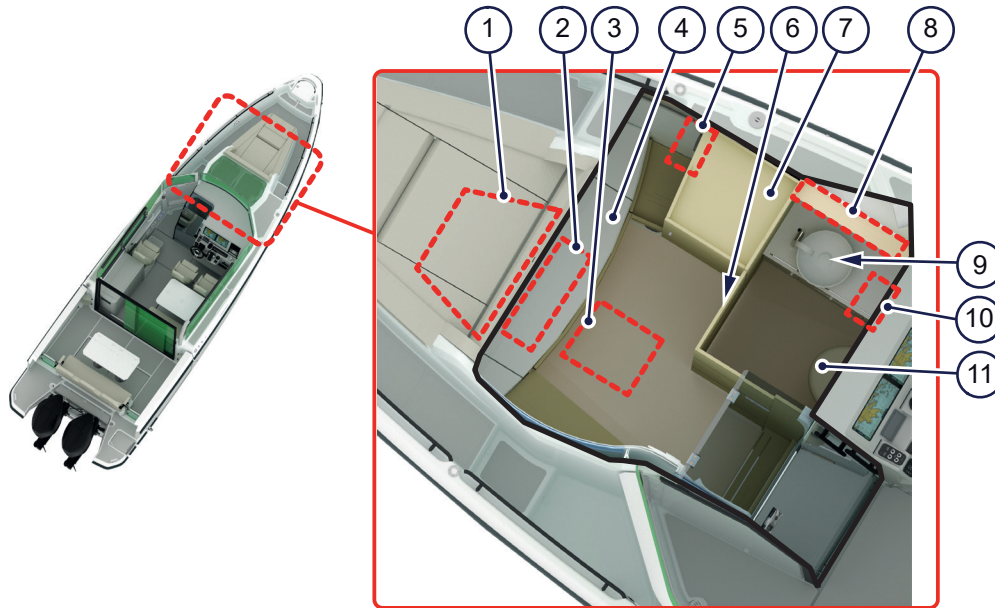

Figure 4.3 - Front cabin

- |   |   |    |                                     |
|---|---|----|-------------------------------------|
| 1 | Cabin technical compartment             | 7  | Wardrobe                            |
| 2 | Cabin bed hatch                         | 8  | Cupboards                           |
| 3 | Cabin floor hatch                       | 9  | Fresh water tap, sink, bidet shower |
| 4 | Bed                                     | 10 | Toilet compartment control panel    |
| 5 | Smoke and carbon monoxide (CO) detector | 11 | Toilet                              |
| 6 | Toilet compartment door                 |    |                                     |

### 4.1.3 Main cabin

Check here the facilities and equipment that you can find in the main cabin.

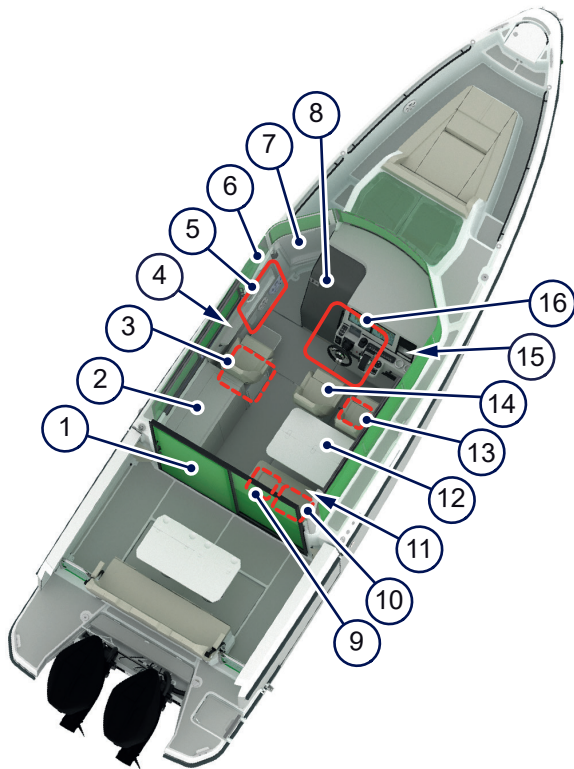

Figure 4.4 - Main cabin

- |   |   |    |   |
|---|---|----|---|
| 1 | Door and doorway to the main cabin          | 9  | Fridge  |
| 2 | Wet bar                                     | 10 | Storage and check hatch for the air-conditioning unit |
| 3 | Fridge                                      | 11 | Sofa  |
| 4 | Wireless phone charger                      | 12 | Table: folding top, electrical lifting and lowering   |
| 5 | Fuse panel and user control panels          | 13 | Battery control panel                                 |
| 6 | Cabin side windows, both sides of the cabin | 14 | Driver's seat   |
| 7 | Door and doorway to the foredeck            | 15 | Glove compartment and wireless phone charger          |
| 8 | Door and doorway to the front cabin         | 16 | Helm station  |

### 4.1.4 Aft deck

See here what you can find on the aft deck.

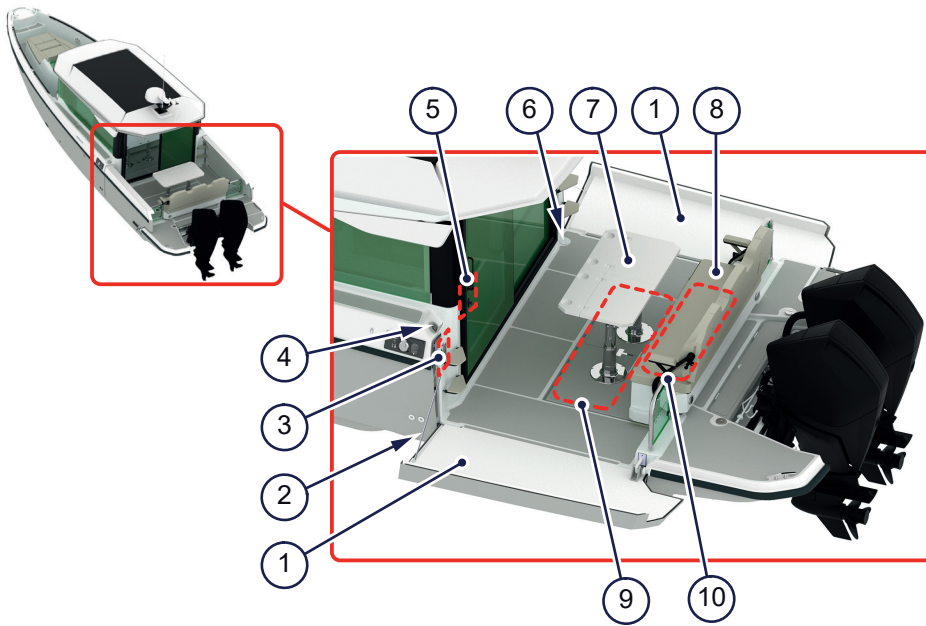

Figure 4.5 - Aft deck

- |   |   |    |                             |
|---|---|----|-----------------------------|
| 1 | Folding side terrace in the lowest locking position | 6  | Grey water discharge outlet |
| 2 | Side terrace securing wire                          | 7  | Table                       |
| 3 | Side terrace latch                                  | 8  | Aft deck seat               |
| 4 | Fresh water shower                                  | 9  | Aft technical compartment   |
| 5 | Side terrace control panel                          | 10 | Storage under the seat      |



### 4.1.5 Bathing platform

See what you can find on the bathing platform.

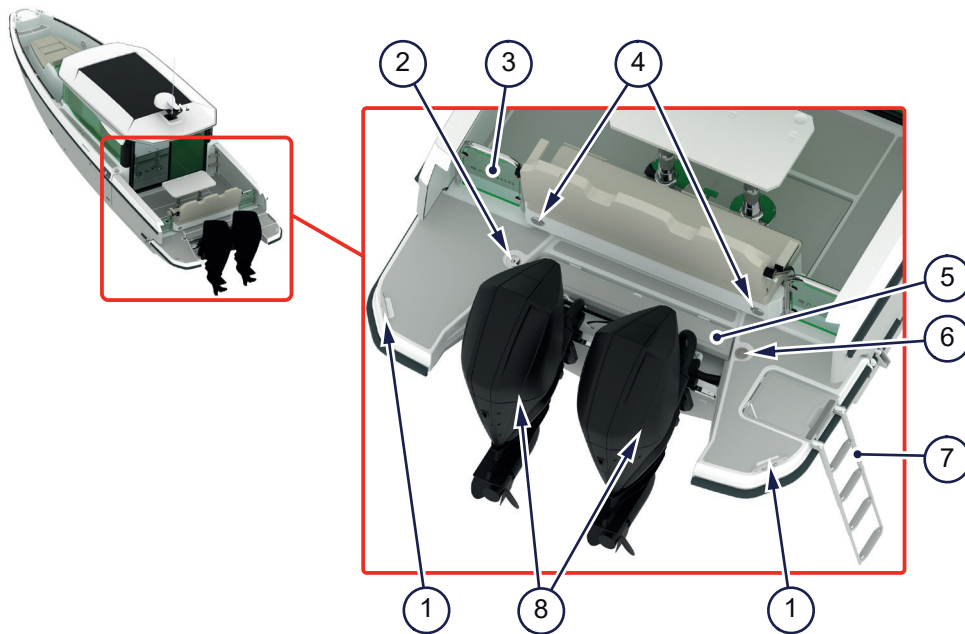

Figure 4.6 - Bathing platform

- |   |   |   |  |
|---|---|---|--|
| 1 | Cleats for towing and mooring               | 5 | Engine well bridge and mounting for the water ski pole |
| 2 | Fresh water inlet                           | 6 | Diesel fuel inlet                                      |
| 3 | Transom gate                                | 7 | Bathing ladder, pulled out from the hatch              |
| 4 | Warning lights for engine joystick piloting | 8 | Twin engines   |

## 4.2 User controls

See here the location of the different user controls on your boat.

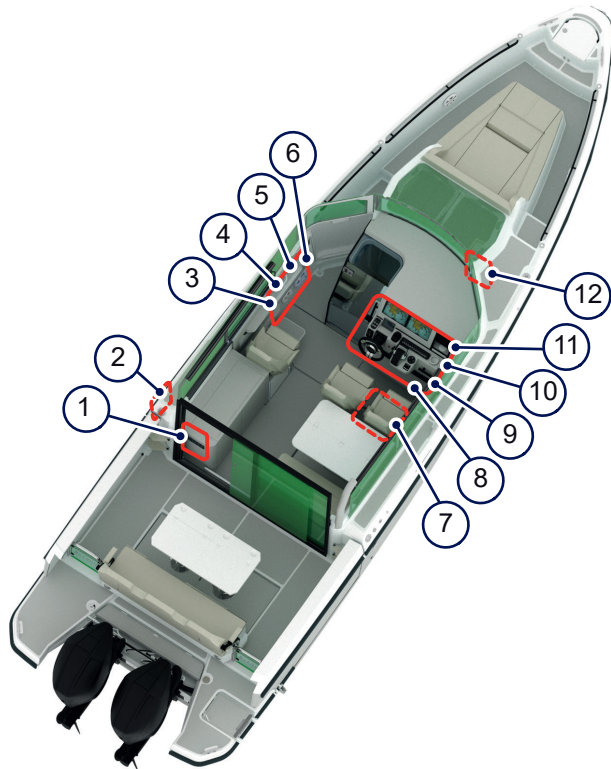

Figure 4.7 - Locations of user controls

- |   |                            |    |                                       |
|---|----------------------------|----|---------------------------------------|
| 1 | Side terrace control panel | 7  | Battery control panel                 |
| 2 | Shore power panel          | 8  | Helm station controls                 |
| 3 | Cooktop control panel      | 9  | Wiper control panel                   |
| 4 | Roof control panel         | 10 | Anchor winch control panel            |
| 5 | Temperature control panel  | 11 | Navigation and lighting control panel |
| 6 | Fuse panel                 | 12 | Toilet compartment control panel      |

## 4.2.1 Helm station controls

Get a quick overview of the locations and names of different controls at the helm station. Drill deeper into the functions available for each control unit in the following sections.

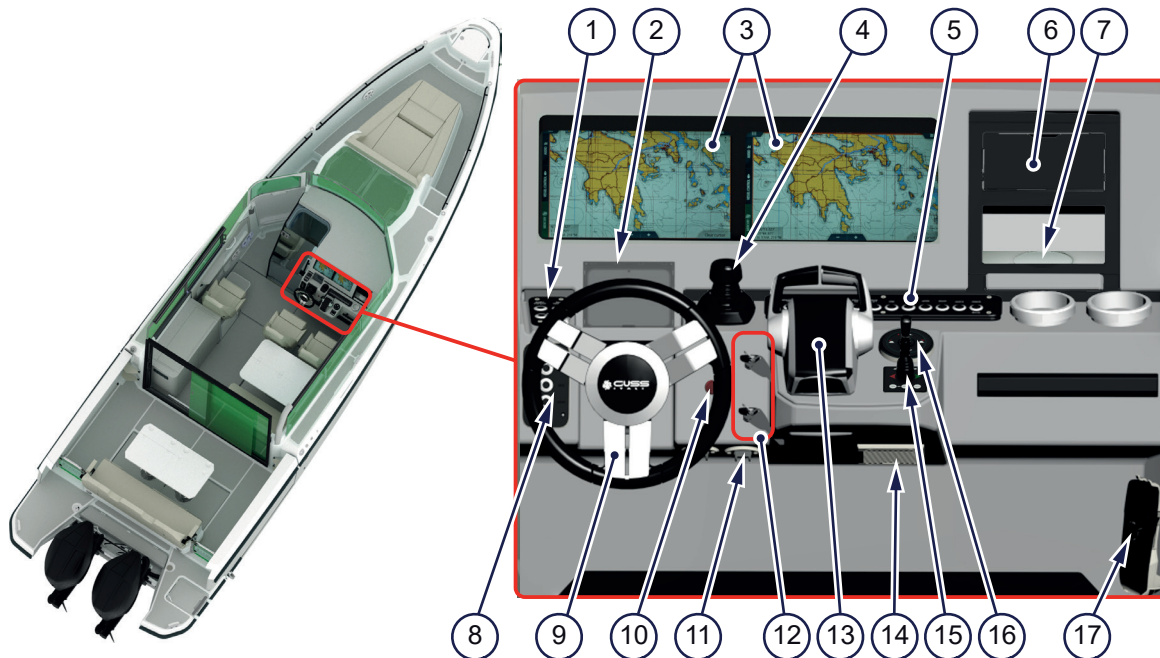

Figure 4.8 - Helm station controls

- |   |   |    |                                   |
|---|---|----|-----------------------------------|
| 1 | Wiper control panel                           | 10 | Autopilot on/off switch           |
| 2 | Engine multifunction display                  | 11 | Lanyard stop switches             |
| 3 | Chartplotter                                  | 12 | Ignition key switches             |
| 4 | Engine joystick                               | 13 | Engine throttle and shift control |
| 5 | Navigation and lighting control panel         | 14 | VHF and AIS speaker               |
| 6 | Diagnostics port and chartplotter card reader | 15 | Trim tabs joystick                |
| 7 | Wireless phone charger and engine USB ports   | 16 | Bow thruster joystick             |
| 8 | Anchor winch control panel                    | 17 | VHF and AIS handset               |
| 9 | Steering wheel                                |    |                                   |

### Learn more

- How to use the engine controls, lanyard stop switch and how to trim your boat: [3.2 Driving and steering on page 22](#)

### Related information

[5.2 Engine and steering system on page 70](#)

[5.6 Navigation equipment on page 79](#)

[5.7 Anchor system on page 80](#)

### 4.2.1.1 Navigation and lighting control panel

The navigation and lighting control panel controls navigation equipment, lights and bilge pumps.

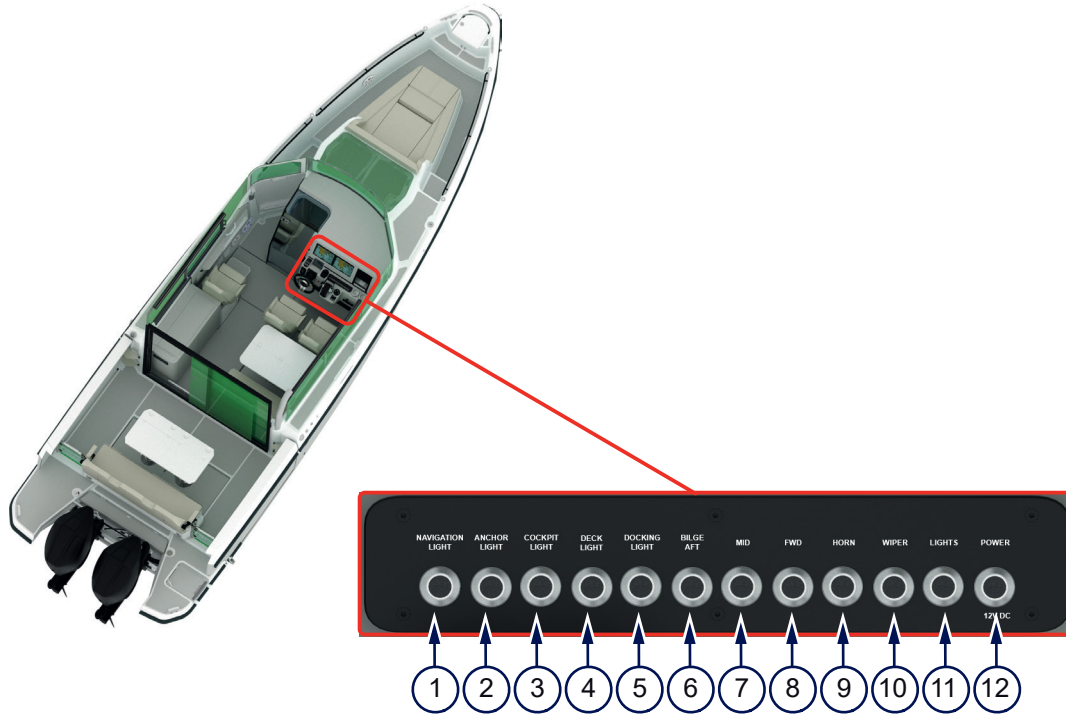

Figure 4.9 - Control functions on the navigation and lighting control panel

- |   |                  |    |               |
|---|------------------|----|---------------|
| 1 | Navigation light | 7  | Bilge mid     |
| 2 | Anchor light     | 8  | Bilge forward |
| 3 | Cockpit light    | 9  | Horn          |
| 4 | Deck light       | 10 | Wiper         |
| 5 | Docking light    | 11 | Panel lights  |
| 6 | Bilge aft        | 12 | Display power |

#### Learn more

- When to use bilge pumps in case of flooding: [2.6.1 What if your boat is flooded?](#) on page 18
- Before departure checklist for navigation: [3.1 Get going!](#) on page 21

#### Related information

[5.4 Draining system](#) on page 73

[5.6 Navigation equipment](#) on page 79

[5.8.9 Lighting and audio](#) on page 87

### 4.2.1.2 Anchor winch control panel

If your boat is equipped with an electrical anchor retaining system, you can lower and lift the anchor from the anchor winch control panel.

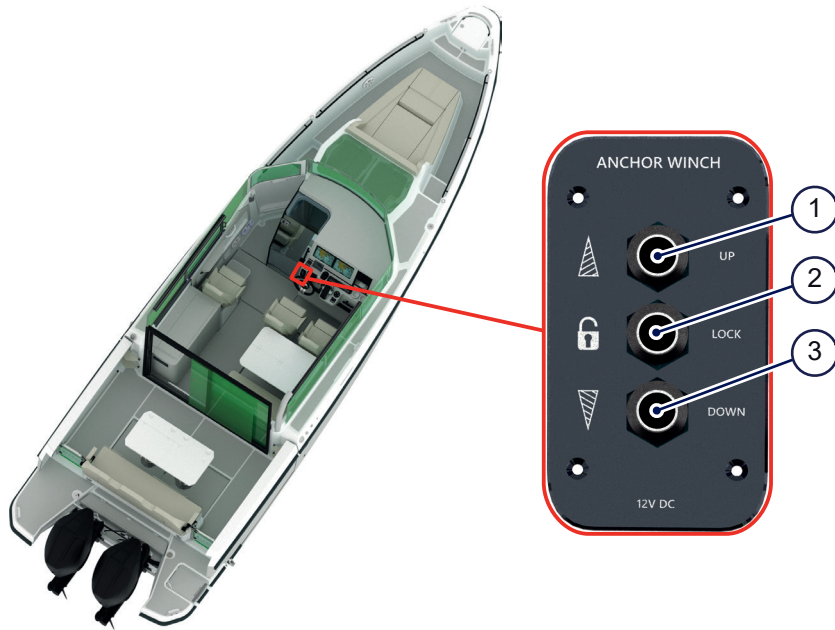

Figure 4.10 - Anchor winch control panel

- |   |                     |   |             |
|---|---------------------|---|-------------|
| 1 | Anchor up           | 3 | Anchor down |
| 2 | Anchor lock release |   |             |

#### Learn more

- About anchoring and anchor chain requirements: [3.3 Mooring, towing and anchoring](#) on page 25

#### Related information

[5.7 Anchor system](#) on page 80

### 4.2.1.3 Wiper control panel

Check here the location of the control panel for the side window wipers on your boat.

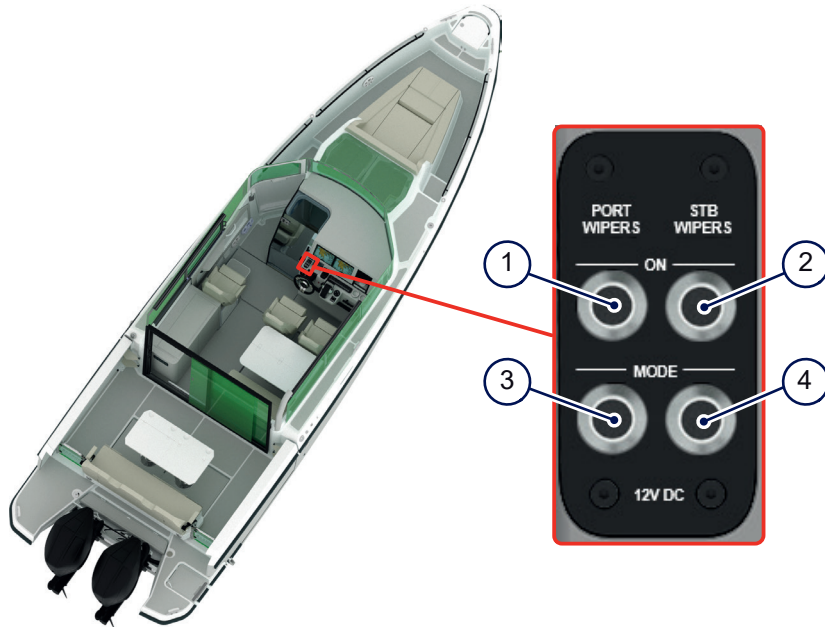

Figure 4.11 - Wiper control panel

- |   |                         |   |                                 |
|---|-------------------------|---|---------------------------------|
| 1 | Port window wipers      | 3 | Port wiper mode adjustment      |
| 2 | Starboard window wipers | 4 | Starboard wiper mode adjustment |



You can find the control button for the windshield wiper in the navigation and lighting control panel.

#### Related information

[4.1.3 Main cabin](#) on page 31

## 4.2.2 Toilet compartment control panel

You can flush the toilet and operate the fresh and waste water (black and grey) pumps from the toilet compartment control panel.

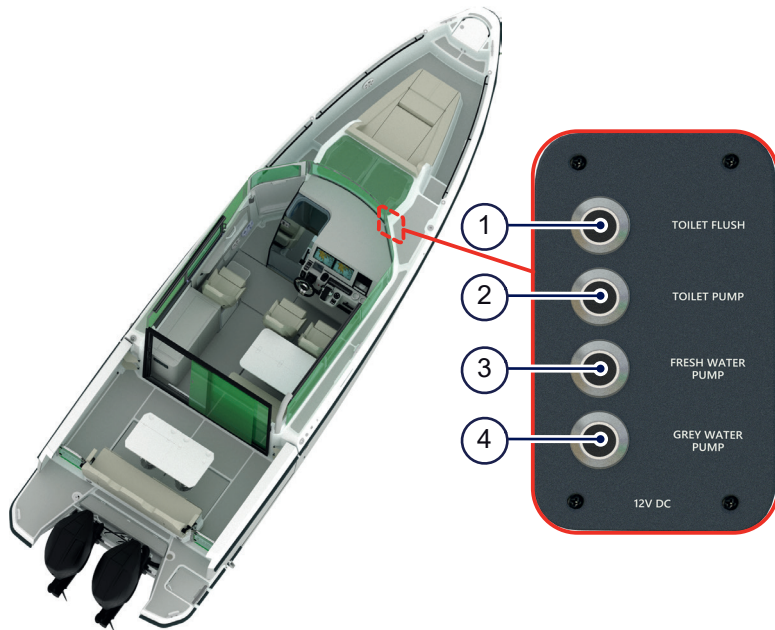

Figure 4.12 - Toilet compartment control panel

- |   |                           |   |                  |
|---|---------------------------|---|------------------|
| 1 | Toilet flush              | 3 | Fresh water pump |
| 2 | Toilet / black water pump | 4 | Grey water pump  |

### Related information

[5.5 Fresh and waste water systems](#) on page 76

## 4.2.3 Side terrace control panel

You can operate the side terraces, the hatch of the aft technical compartment, and the fresh water pump from the side terrace control panel.

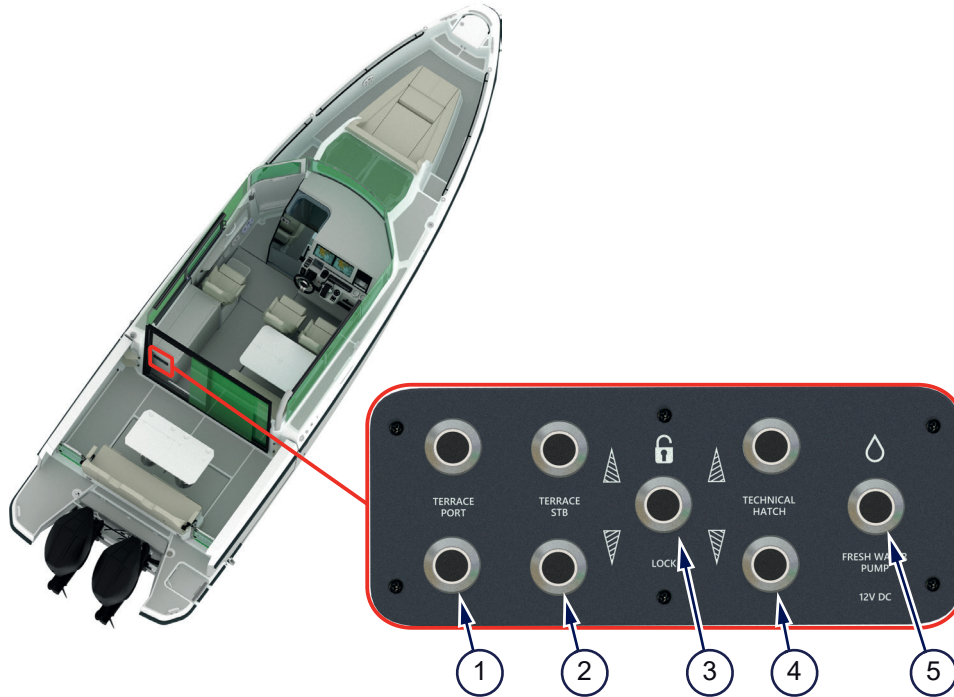

Figure 4.13 - Side terrace control panel

- |   |                           |   |  |
|---|---------------------------|---|--|
| 1 | Port terrace down/up      | 4 | Aft technical compartment hatch open/close |
| 2 | Starboard terrace down/up | 5 | Fresh water pump                           |
| 3 | Terrace lock release      |   |  |

### Related information

[4.6.4 Hatches](#) on page 59

[5.5 Fresh and waste water systems](#) on page 76

[5.8.4 Side terraces](#) on page 84



## 4.2.4 Roof control panel

You can use the roof control panel to open and close the canvas top of the roof hatch of the main cabin. In addition, you can use the panel to adjust the lights on the ceiling of the main cabin.

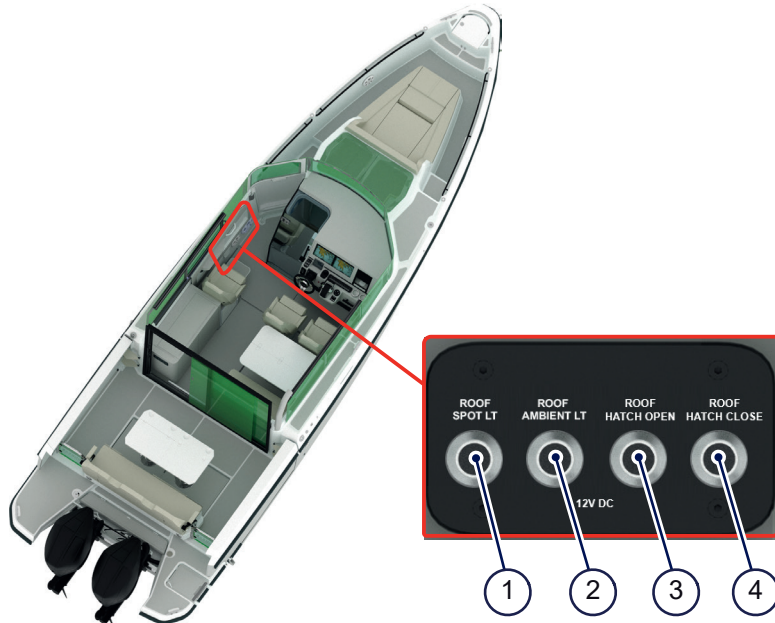

Figure 4.14 - Roof control panel

- |   |                           |   |                  |
|---|---------------------------|---|------------------|
| 1 | Roof spot light switch    | 3 | Roof hatch open  |
| 2 | Roof ambient light switch | 4 | Roof hatch close |

### Related information

[4.1.3 Main cabin](#) on page 31

## 4.2.5 Fuse panel

The fuse panel contains the fuses, switches and indicators for the electrical equipment on your boat.

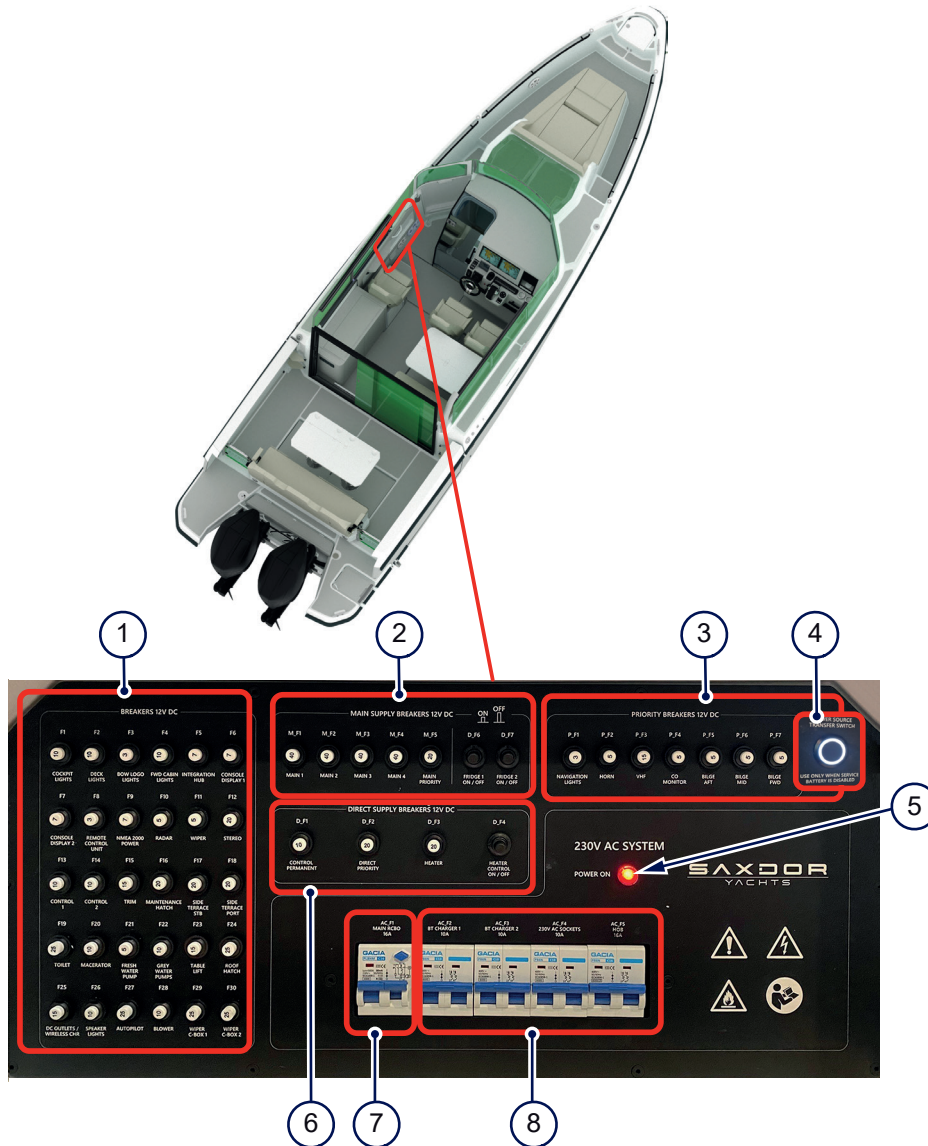

Figure 4.15 - Front cabin fuse panel

- |   |                              |   |  |
|---|------------------------------|---|--|
| 1 | Fuses 12 V                   | 5 | Shore power indicator light                      |
| 2 | Main supply fuses            | 6 | Direct supply fuses                              |
| 3 | Priority fuses               | 7 | Shore power main switch / overcurrent protection |
| 4 | Power source transfer switch | 8 | Shore power 110 V or 230 V fuses                 |

### Related information

[5.1.2 Fuses](#) on page 63

[9.2 Electrical wiring diagram](#) on page 97

## 4.2.6 Battery control panel

The battery control panel contains the battery on/off switches. You can use the switches to turn power off from the batteries to the equipment on your boat when you leave the boat unattended, and turn power on when you return.

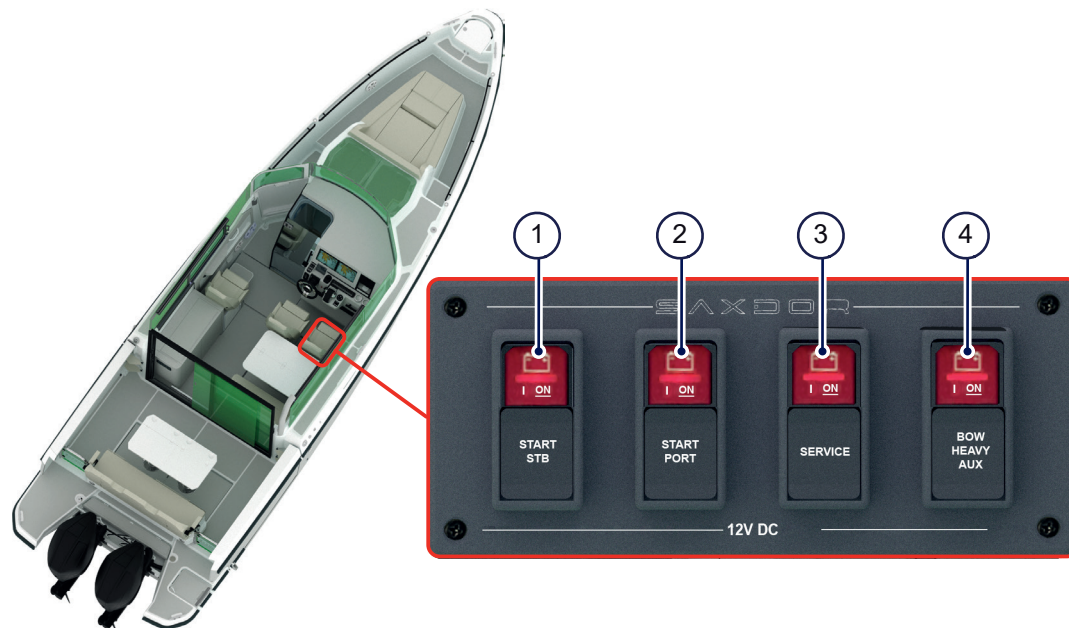

Figure 4.16 - Battery control panel

- |   |                          |   |                   |
|---|--------------------------|---|-------------------|
| 1 | Starboard engine battery | 3 | Service battery   |
| 2 | Port engine battery      | 4 | Auxiliary battery |

### Related information

[5.1 Electrical system](#) on page 61

[5.1.3 Batteries](#) on page 65

## 4.2.7 Shore power panel

You can connect your boat to shore power from the shore power panel.

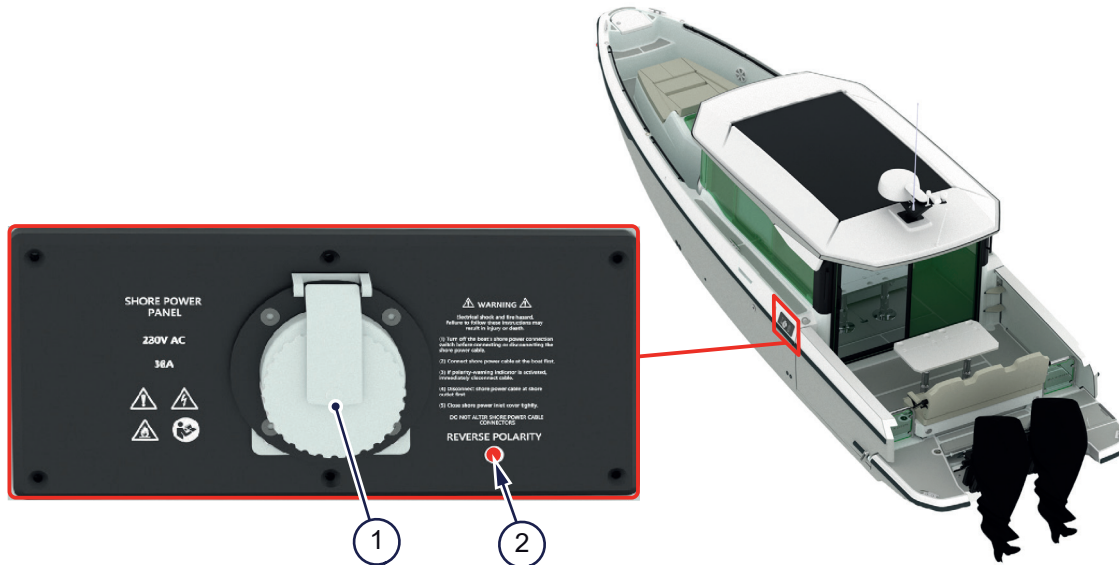

Figure 4.17 - Shore power panel

- 1 Shore power inlet
- 2 Reverse polarity indicator

### Related information

[5.1.4 Shore power](#) on page 66

## 4.2.8 Cooktop control panel

You can use the cooktop control panel to operate the optional diesel-powered cooktop on the wet bar.

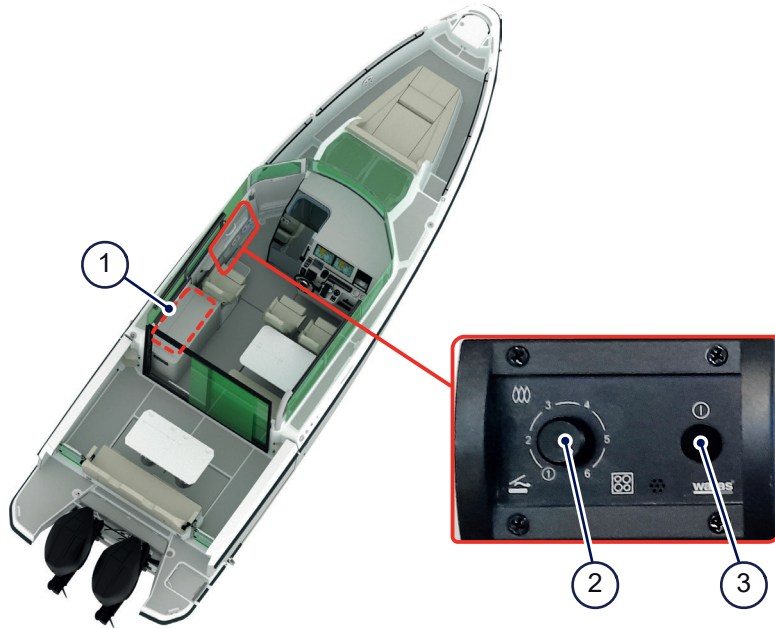

Figure 4.18 - Cooktop control panel

- |   |                      |   |                      |
|---|----------------------|---|----------------------|
| 1 | Cooktop              | 3 | Cooktop power on/off |
| 2 | Cooktop heat setting |   |                      |

Check the cooktop manufacturer's manual for more information on the features and the use of the equipment.

### Related information

[5.8.2 Wet bar](#) on page 82

## 4.2.9 Temperature control panel

Check here the location of your boat's temperature control panel.

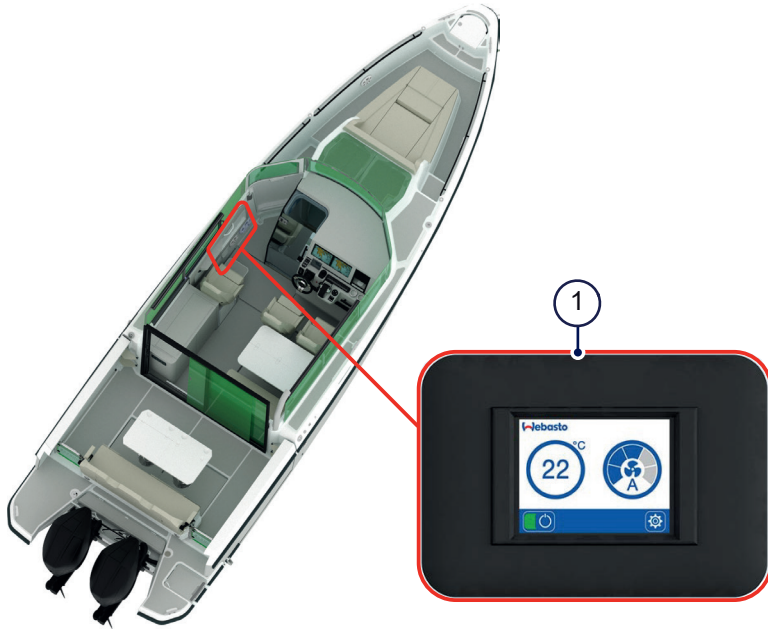

Figure 4.19 - Temperature control panel

- 1 Temperature control panel

### Related information

[5.8.1 Heating and air-conditioning](#) on page 81

## 4.3 Builder's plate

Check the location and details on the builder's plate on your boat.

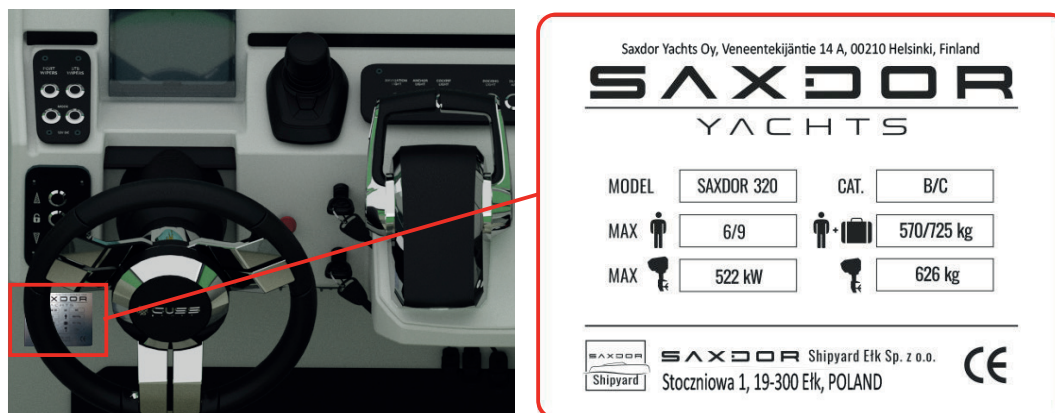

Figure 4.20 - Builder's plate



The maximum load indicated on the plate does not include fuel.

### Learn more

- About the purpose of the builder's plate: [2.3 What is builder's plate?](#) on page 13

## 4.4 Hull identification number

Hull identification number (HIN) is a unique identifier for your boat and can be used to track your boat's history.

Contact your Saxdor dealer if you need to find out your boat's HIN or its location. Never remove or alter your boat's HIN.

## 4.5 Safety on board

Check here the basic safety features on your boat.

### 4.5.1 Safety equipment and emergency exits

Check here the location of your boat's safety equipment and emergency exits.

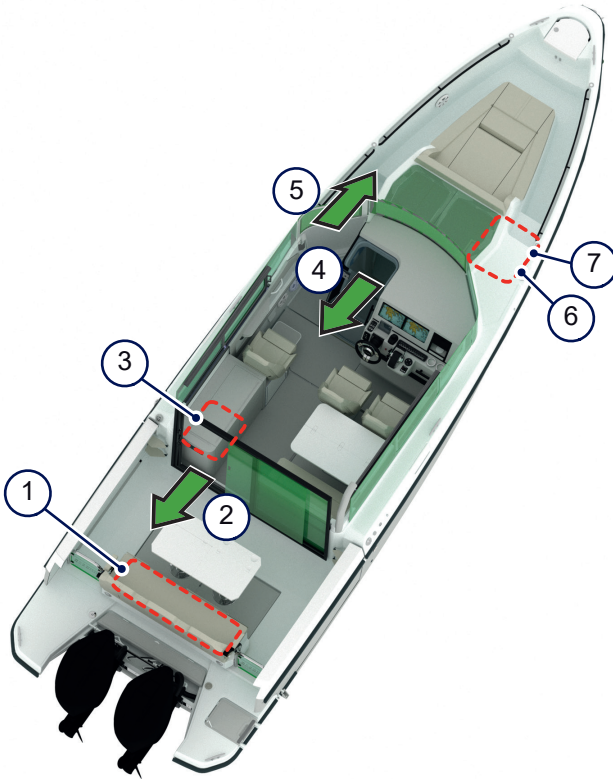

Figure 4.21 - Safety equipment and emergency exits

- |   |  |   |  |
|---|--|---|--|
| 1 | Recommended location for the life raft   | 5 | Emergency exit from the main cabin to the foredeck                               |
| 2 | Emergency exit from the main cabin to the aft deck                                 | 6 | CO detector and recommended location for the smoke detector (in the front cabin) |
| 3 | Recommended location for the fire extinguisher (in the cupboard under the wet bar) | 7 | Recommended location for the fire extinguisher (in the toilet compartment)       |
| 4 | Emergency exit from the front cabin through the doorway                            |   |  |



## 4.5.2 Safe seating and moving areas

See where the passengers are allowed to be seated and move about in different situations.

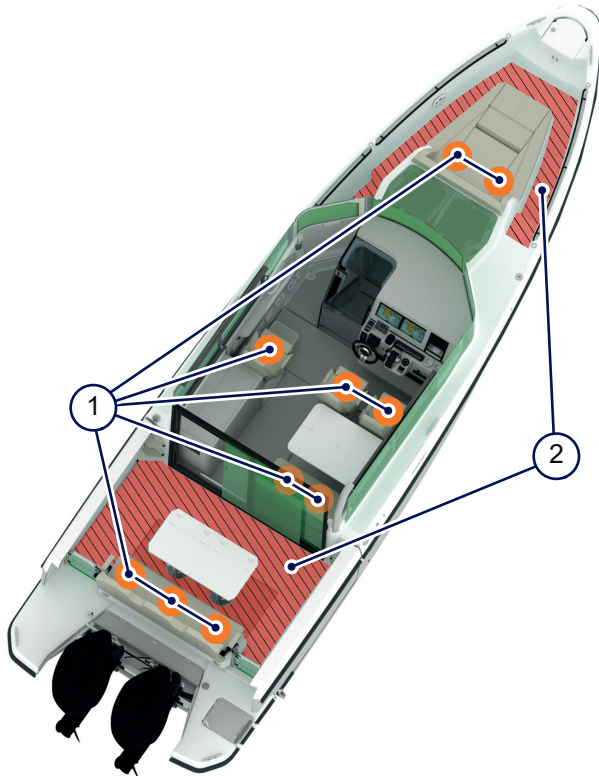

Figure 4.22 - Safe seating and moving areas

- 1 Allowed seating
- 2 Working deck area

### Learn more

- Limitations on the number of people on board: [2.4 What is design category?](#) on page 14
- Using the designated areas: [2.5.2 Move safely on board](#) on page 16
- How to recover people from the water: [2.6.2 Man overboard!](#) on page 19

## 4.5.3 Safety labels on board

The safety labels on your boat emphasize important safety precautions, which every crew member must pay attention to. Check here what safety labels there are on your boat and where they are located.

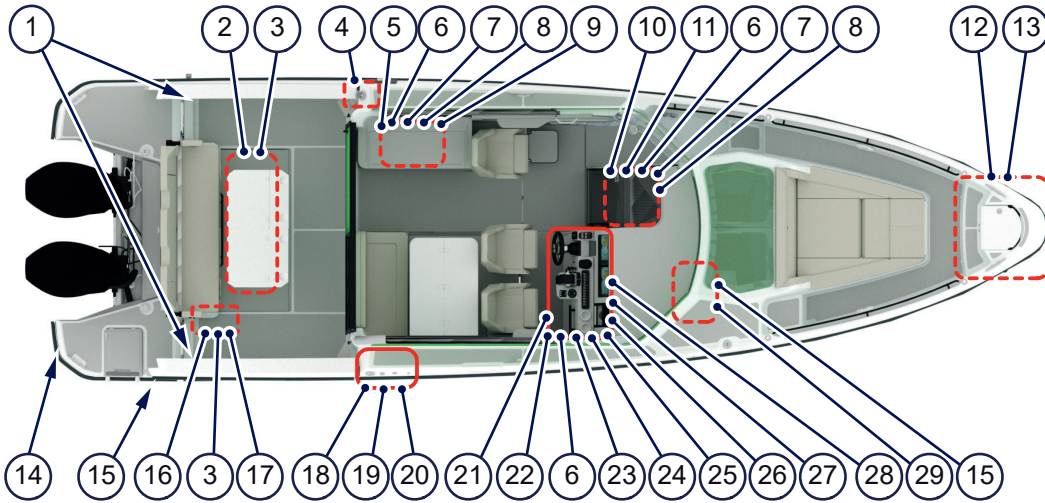

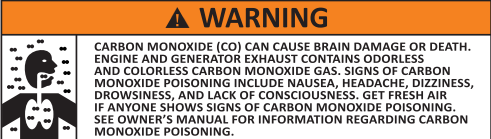
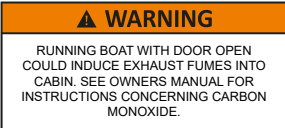
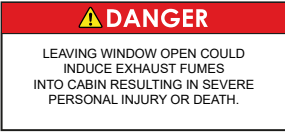
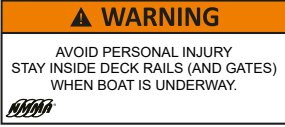

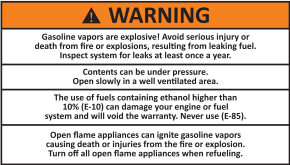

Figure 4.23 - Location of safety labels on your boat



Table 4.1 - Safety labels on board





Number	Label	Clarification
1		<p>Warning</p> <p>Keep the transom gate shut when underway. If the gate is open, serious injury may result from falling into water and near the propeller.</p>
2		<p>WARNING</p> <p>A watertight closure.</p> <p>Keep the closure shut when the boat is underway</p>
3		<p>WARNING</p> <p>No ventilation is provided. The fuel vapors are a fire and explosion hazard. To avoid injury or death, do not store fuel or flammable liquids here.</p>

Number	Label	Clarification
4	 <p><b>⚠ WARNING</b> ELECTRICAL SHOCK AND FIRE HAZARD. FAILURE TO FOLLOW THESE INSTRUCTIONS MAY RESULT IN INJURY OR DEATH. (1) Turn off the boat's shore power connection switch before connecting or disconnecting the shore power cable. (2) Connect shore power cable at the boat first. (3) If polarity-warning indicator is activated, immediately disconnect cable. (4) Disconnect shore power cable at shore outlet first. (5) Close shore power inlet cover tightly. DO NOT ALTER SHORE POWER CABLE CONNECTORS</p>	<p><b>WARNING</b></p> <p>Electrical shock and fire hazard. Failure to follow these instructions may result in injury or death.</p> <ol style="list-style-type: none"> <li>1. Turn off the boat's shore power connection switch before connecting or disconnecting the shore power cable.</li> <li>2. Connect the shore power cable at the boat first.</li> <li>3. If the polarity-warning indicator is activated, immediately disconnect the cables.</li> <li>4. Disconnect the shore power cable at the shore outlet first.</li> <li>5. Close the shore power inlet cover tightly.</li> </ol> <p>Do not alter the shore power cable connectors.</p>
5	 <p><b>⚠ WARNING</b> Non-potable water. Do not drink.</p>	<p><b>WARNING</b></p> <p>The water in the fresh water system is non-potable. Do not drink it. → IN THE WET BAR; ADD THE NUMBER</p>
6	 <p><b>⚠ WARNING</b> CARBON MONOXIDE (CO) CAN CAUSE BRAIN DAMAGE OR DEATH. ENGINE AND GENERATOR EXHAUST CONTAINS ODORLESS AND COLORLESS CARBON MONOXIDE GAS. SIGNS OF CARBON MONOXIDE POISONING INCLUDE NAUSEA, HEADACHE, DIZZINESS, DROWSINESS, AND LACK OF CONSCIOUSNESS. GET FRESH AIR IF ANYONE SHOWS SIGNS OF CARBON MONOXIDE POISONING. SEE OWNER'S MANUAL FOR INFORMATION REGARDING CARBON MONOXIDE POISONING.</p>	<p><b>WARNING</b></p> <p>Carbon monoxide (CO) can cause brain damage or death. Engine and generator exhaust contains odorless and colorless carbon monoxide gas. Signs of carbon monoxide poisoning include nausea, headache, dizziness, drowsiness, and lack of consciousness. Get fresh air if anyone shows signs of carbon monoxide poisoning. See the owner's manual for information regarding carbon monoxide poisoning.</p>
7	 <p><b>⚠ WARNING</b> RUNNING BOAT WITH DOOR OPEN COULD INDUCE EXHAUST FUMES INTO CABIN. SEE OWNERS MANUAL FOR INSTRUCTIONS CONCERNING CARBON MONOXIDE.</p>	<p><b>WARNING</b></p> <p>Running the boat when the door marked with the warning is open could induce exhaust fumes into cabin. See the owner's manual for instructions concerning carbon monoxide.</p>
8	 <p><b>⚠ DANGER</b> LEAVING WINDOW OPEN COULD INDUCE EXHAUST FUMES INTO CABIN RESULTING IN SEVERE PERSONAL INJURY OR DEATH.</p>	<p><b>DANGER</b></p> <p>Leaving window open could induce exhaust fumes into cabin resulting in severe personal injury or death.</p>
9	 <p><b>⚠ WARNING</b> AVOID PERSONAL INJURY STAY INSIDE DECK RAILS (AND GATES) WHEN BOAT IS UNDERWAY.</p>	<p><b>WARNING</b></p> <p>Avoid personal injury.</p> <p>Stay inside the deck rails (and gates) when the boat is underway.</p>

Number	Label	Clarification
10		Warning Keep the door shut when the boat is moving.
11		Indicates a designated emergency exit.
12		WARNING Keep the hatch shut all the time.
13		Danger The sun beds on the foredeck or on the aft deck should not be used when the boat is moving.
14		WARNING A rotating propeller may cause a serious injury or death. Do not reboard the boat when the engine is running.
15		DANGER Carbon monoxide (CO) can cause brain damage or death. Engine and generator exhaust contains odorless and colorless carbon monoxide gas. Carbon monoxide will be around the back of the boat when engines or generators are running. Move to fresh air if you feel nausea, headache, dizziness or drowsiness.
16		Indicates the location of a fire extinguisher.
17		DANGER The aft deck folding seats should not be used when the boat's speed is over 5 M.P.H.

Number	Label	Clarification
18	 <p><b>▲ WARNING</b> Gasoline vapors are explosive! Avoid serious injury or death from fire or explosions, resulting from leaking fuel. Inspect system for leaks at least once a year. Contents can be under pressure. Open slowly in a well ventilated area. The use of fuels containing ethanol higher than 10% (E-10) can damage your engine or fuel system and will void the warranty. Never use (E-85). Open flame appliances can ignite gasoline vapors causing death or injuries from the fire or explosion. Turn off all open flame appliances when refueling.</p>	<p><b>WARNING</b></p> <p>Gasoline vapors are explosive! Avoid serious injury or death from fire or explosions, resulting from leaking fuel. Inspect the system for leaks at least once a year.</p> <p>The contents can be under pressure. Open slowly in a well ventilated area.</p> <p>The use of fuels containing ethanol higher than 10% (E-10) can damage your engine or fuel system and will void the warranty. Never use (E-85).</p> <p>Open flame appliances can ignite gasoline vapors, causing death or injuries from fire or explosion. Turn off all open flame appliances when refueling.</p>
19	 <p><b>▲ WARNING</b> GASOLINE VAPOURS MAY CAUSE FIRES OR EXPLOSIONS Do not overfill fuel tank. Keep the craft away from open flames and sparks. Do not start craft in liquid gasoline or vapours are presented. Always replace engine cover (or seat) before starting.</p>	<p><b>WARNING</b></p> <p>Gasoline vapours may cause fires or explosions. Do not overfill the fuel tank. Keep the boat away from flames and sparks. Do not start the engine if liquid gasoline or vapours are present. Always replace the engine cover (or seat) before starting.</p>
20	 <p><b>▲ WARNING</b> AVOID SERIOUS INJURY OR DEATH FROM FIRE OR EXPLOSION RESULTING FROM LEAKING FUEL Inspect system for leaks frequently</p>	<p><b>Warning</b></p> <p>Leaking fuel can cause fire or explosion which may lead to serious injury or death.</p>

Number	Label	Clarification
21	<p style="text-align: center;"><b>BOATMAN'S CHECK LIST</b></p> <p>For maximum enjoyment and safety, check each of these items BEFORE you start your engine:</p> <ul style="list-style-type: none"> <li>✓DRAIN PLUG (Securely in place?)</li> <li>✓LIFE-SAVING DEVICES (One for each person on board?)</li> <li>✓STEERING SYSTEM (Working smoothly and properly?)</li> <li>✓FUEL SYSTEM (Adequate fuel? Leaks? Fumes?)</li> <li>✓BATTERY (Fully charged? Cable terminals clean and tight?)</li> <li>✓ENGINE (In neutral?)</li> <li>✓CAPACITY PLATE (Are you overloaded or overpowered?)</li> <li>✓WEATHER CONDITIONS (Safe to go out?)</li> <li>✓ELECTRICAL EQUIPMENT (Lights, horn, pump, etc.?)</li> <li>✓EMERGENCY GEAR (Fire extinguisher, bailer, paddle, anchor &amp; line. Signaling device, tool kit, etc.?)</li> </ul>  <p style="text-align: right;">© NMMA 1981</p>	<p><b>BOATMAN'S CHECKLIST</b></p> <p>For maximum safety and enjoyment, check each of the items listed on the label BEFORE you start your engine:</p> <ul style="list-style-type: none"> <li>• DRAIN PLUGS (Securely in place?)</li> <li>• LIFE-SAVING DEVICES (One for every person on board?)</li> <li>• STEERING SYSTEM (Working smoothly and properly?)</li> <li>• FUEL SYSTEM (Adequate fuel? Leaks? Fumes?)</li> <li>• BATTERY (Fully charged? Cable terminals clean and tight?)</li> <li>• ENGINE (In neutral?)</li> <li>• CAPACITY PLATE (Are you overloaded or overpowered?)</li> <li>• WEATHER CONDITIONS (Safe to go out?)</li> <li>• ELECTRICAL EQUIPMENT (Lights, horn, pump, etc. work OK?)</li> <li>• EMERGENCY GEAR (Fire extinguisher, bailer, paddle, anchor &amp; line, signaling device, tool kit, etc. OK and available on board?)</li> </ul>
22		<p>Label indicating the certification by the International Marine Certification Institute (IMCI)</p>
23	<div style="border: 1px solid black; padding: 5px;"> <p style="text-align: center;"><b>⚠ WARNING</b></p> <p style="font-size: small;">QUALIFIED OPERATOR TO BE IN CONTROL AT ALL TIMES. OPERATION BY AN UNQUALIFIED OPERATOR CAN CAUSE LOSS OF CONTROL. THIS MAY RESULT IN SEVERE INJURY, DEATH OR PROPERTY DAMAGE. BOAT STABILITY AND HANDLING WILL CHANGE WITH WEIGHT DISTRIBUTION. READ OWNERS MANUAL BEFORE USE.</p> </div>	<p><b>WARNING</b></p> <p>A qualified operator must be in control at all times. Operation by an unqualified operator can cause loss of control. This may result in severe injury, death or property damage. Boat stability and handling will change with weight distribution. Read the owner's manual before use.</p>
24	<div style="border: 1px solid black; padding: 5px;"> <p style="text-align: center;"><b>⚠ WARNING</b></p> <p style="font-size: small;">ATTACH SHUT DOWN SWITCH LANYARD TO QUALIFIED OPERATOR WHILE ENGINE IS IN OPERATION. UNCONTROLLED BOAT MAY CAUSE INJURY OR DEATH. READ OWNERS MANUAL BEFORE USE.</p> </div>	<p><b>WARNING</b></p> <p>Attach the shut down switch lanyard to a qualified operator while the engine is in operation. An uncontrolled boat may cause injury or death. Read the owner's manual before use.</p>
25	<div style="border: 1px solid black; padding: 5px;"> <p style="text-align: center;"><b>⚠ WARNING</b></p> <p style="font-size: small;">ROTATING PROPELLER MAY CAUSE SERIOUS INJURY OR DEATH. SHUT OFF ENGINE WHEN NEAR PERSONS IN THE WATER</p> </div>	<p><b>WARNING</b></p> <p>A rotating propeller may cause a serious injury or death. Shut off the engine when there are people in the water near the boat.</p>

Number	Label	Clarification
26		<p>WARNING</p> <p>Use caution when a skier is in tow as the tow rope may backlash into the cockpit when released.</p>
27		<p>Label calling attention to reading the manual and paying attention to the warning labels.</p>
28		<p>WARNING</p> <p>Use the Throttle Only button to avoid unintended gear engagement when the captain is not at the helm.</p>
29		<p>Toilet inlet shutoff valve</p>

## 4.6 Hull and deck

See here the features and equipment on the hull and deck.

### 4.6.1 Attachment points

Your boat is equipped with cleats for mooring, towing and attaching the boat onto a trailer.

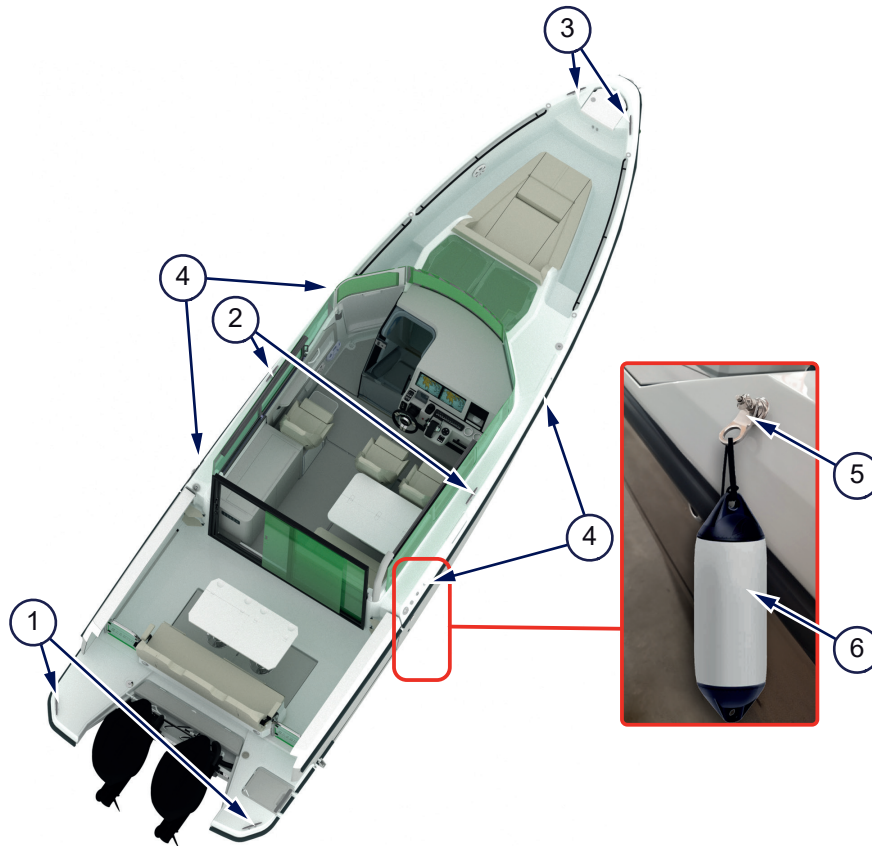

Figure 4.24 - Attachment points

- |   |               |   |                        |
|---|---------------|---|------------------------|
| 1 | Aft cleats    | 4 | Fender cleat mountings |
| 2 | Middle cleats | 5 | Fender cleat           |
| 3 | Bow cleats    | 6 | Fender                 |

When mooring, you can attach the fenders to your boat with the help of removable fender cleats. The fender cleats prevent the fender ropes from scraping against the hull of your boat.

**⚠ CAUTION** Risk of injury to people, risk of damage to your boat or other vessels.

The protruding fender cleats may collide with people or other boats when driving.  
Remove the fender cleats before you drive.

**Learn more**

- About how to use the cleats and fenders: [3.3 Mooring, towing and anchoring](#) on page 25



### 4.6.2 Lifting points

Check here the approximate locations for the lifting points of your boat as measured from the end of the keel in the aft of the boat.

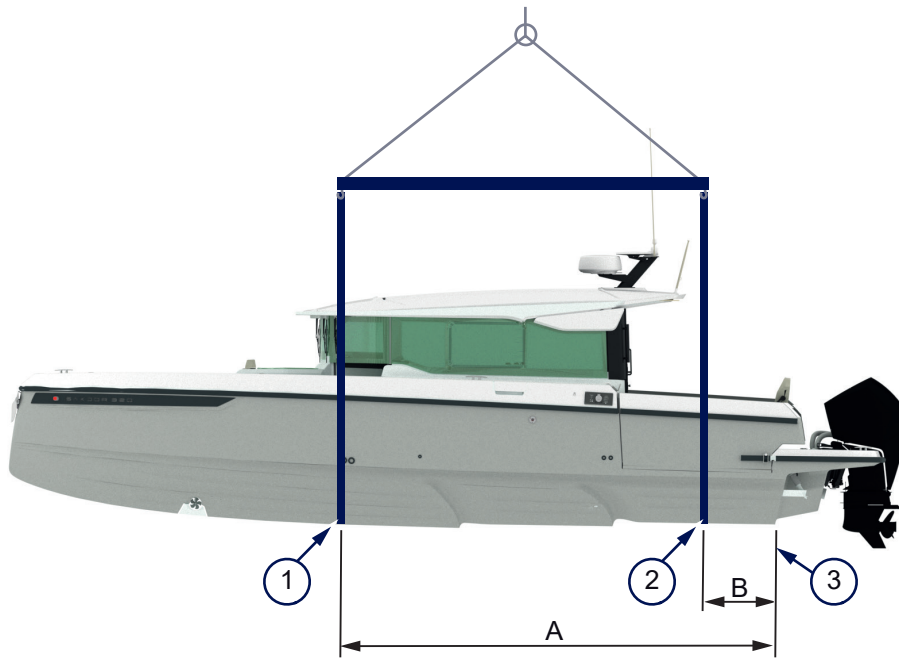

Figure 4.25 - Lifting points

- 1 Lifting point in the bow
- 2 Lifting point in the aft
- 3 Measuring point in the end of the keel

Table 4.2 - Lifting point locations

Dimension	Description	Value	
A	Minimum distance from the measuring point in the end of the keel to the lifting point in the bow	5.2 m	17.1 ft
B	Minimum distance from the measuring point in the end of the keel to the lifting point in the aft	0.75 m	2.5 ft

**Learn more**

- How to lift your boat: [3.4 Lifting and trailering](#) on page 26

### 4.6.3 Hull openings

Your boat has a number of openings through the hull. Check here their locations.

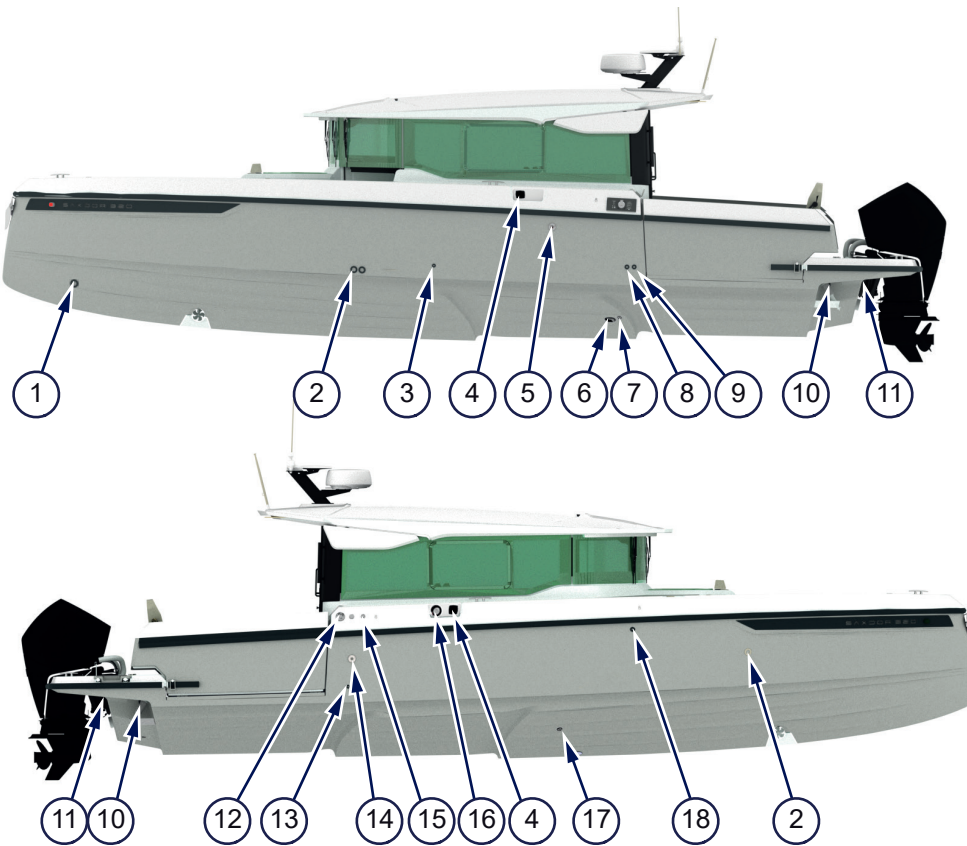

Figure 4.26 - Hull openings

- |   |   |    |                                 |
|---|---|----|---------------------------------|
| 1 | Anchor box draining opening             | 10 | Aft deck draining opening       |
| 2 | Foredeck draining opening               | 11 | Engine well draining opening    |
| 3 | Bow bilge pump draining opening         | 12 | Gasoline fuel tank vent         |
| 4 | Fuel tank vent                          | 13 | Air-conditioner water discharge |
| 5 | Diesel-powered cooktop exhaust          | 14 | Black water seacock opening     |
| 6 | Air-conditioner water intake            | 15 | Grey water tank vent            |
| 7 | Grey water seacock opening              | 16 | Heater air intake               |
| 8 | Mid and aft bilge pump draining opening | 17 | Black water seacock opening     |
| 9 | Manual bilge pump draining opening      | 18 | Black water tank vent           |

## 4.6.4 Hatches

The hatches provide you access to the front cabin, the equipment and systems on your boat. Some of them also act as storage space and emergency exits.

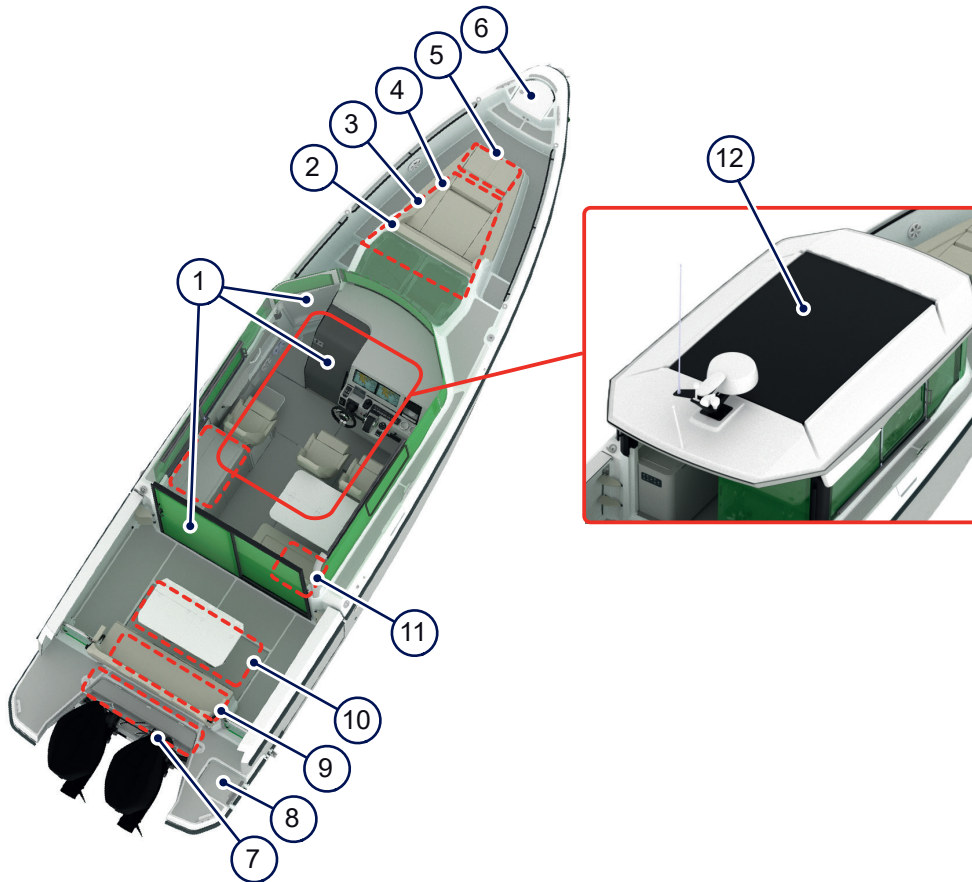

Figure 4.27 - Hatches

1	Door and doorway to the aft deck (emergency exit)	9	Foredeck hatch
2	Cupboards under the wet bar	10	Anchor box hatch
3	Main cabin side windows	11	Engine well bridge
4	Door and doorway to the front cabin (emergency exit)	12	Bathing ladder hatch
5	Door and doorway to the foredeck (emergency exit)	13	Storage space (under the aft deck seat)
6	Cabin floor hatch	14	Aft technical compartment
7	Cabin bed hatch	15	Air conditioning check hatch (under the main cabin sofa)
8	Cabin technical compartment (under the bed)	16	Roof hatch

### Related information

[4.5.1 Safety equipment and emergency exits](#) on page 48

[5.1 Electrical system](#) on page 61

[5.7 Anchor system](#) on page 80

[5.8.7 Bathing ladder](#) on page 87

## 5 The how of your boat

Learn here how the different systems on your boat work and how to use them.

If you need more detailed, step-by-step instructions in using the equipment, refer to the equipment manufacturer's manuals provided in the Saxdor documentation bag.

### 5.1 Electrical system

The electrical system of your boat consists of a state-of-the-art power package which covers your power needs onshore and offshore.

**⚠ DANGER**

Risk of electric shock, fire or explosion.

Remember that water and electricity are a bad combination.

Let only a competent marine electrical technician carry out any installation, alteration or maintenance work to the electrical system.

**⚠ WARNING**

Risk of death, electric shock or injury.

Working on the electrical installation while the system is energized can cause an electric shock.

Never work on the electrical installation while the system is energized.

**⚠ WARNING**

Risk of electric shock or damage to the equipment.

Never alter or modify the rated current amperage of overcurrent protective devices.

The power package is a combination of batteries, shore power and the components of the generator replacement system. The NMEA network connects the different components of your power package. You can monitor the operation of the power package with the CZone application on the chartplotter.



The less you use the electrical equipment on your boat, the longer the system can give you power.

Check here the different components of the electrical system.

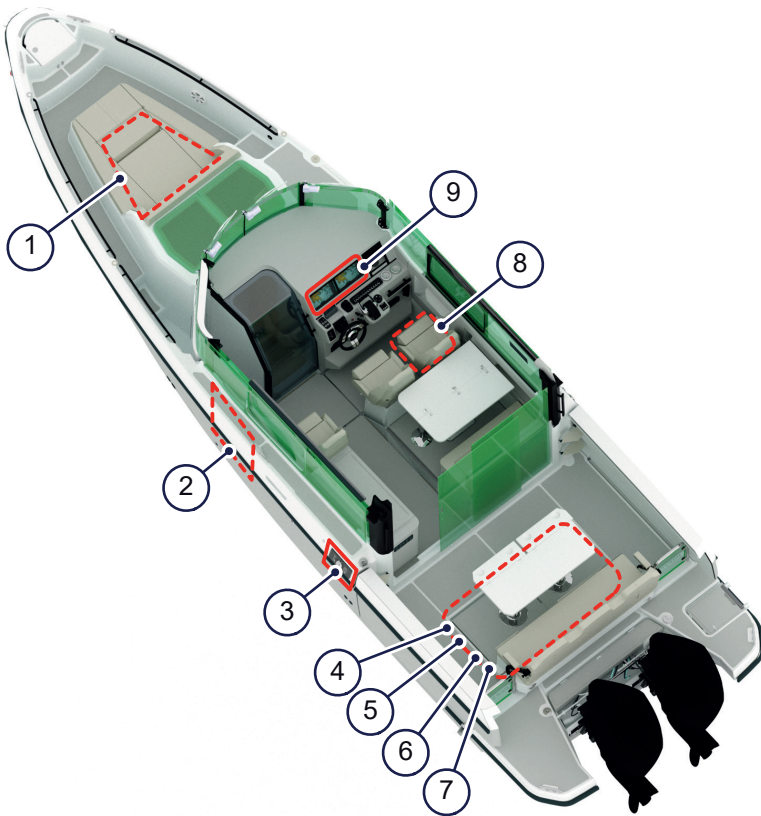

Figure 5.1 - Electrical system

1	Auxiliary battery	6	Shore power battery charger and inverter
2	Fuse panel	7	Generator replacement system
3	Shore power panel	8	Battery control panel
4	Engine batteries	9	CZone application on the chartplotter
5	Service battery		

### Related information

[4.2.5 Fuse panel](#) on page 42

[4.2.6 Battery control panel](#) on page 43

## 5.1.1 Main switches and indicators

The front cabin fuse panel contains main switches and indicators for the equipment on your boat.

- The shore power main switch needs to be on when connecting to shore power. In addition, the main switch protects the boat from an overcurrent fault and a ground fault.
- The shore power indicator light is on when the shore power is connected and off when disconnected.
- The generator replacement system on/off switch needs to be pressed down to turn on the backup power supply if there is a fault in the generator replacement system. When the system works normally, the switch is up.



The backup power supply from the starboard engine battery powers up only the priority equipment. Other equipment get the power from their dedicated batteries.

### Related information

[4.2.5 Fuse panel](#) on page 42

#### 5.1.1.1 Switching power on and off

To save battery power and for safety reasons, always switch the power off when you leave your boat unattended and switch the power on when you return.

#### CAUTION

Risk of electric shock.

Do not touch the batteries or electric connections.



To keep the boat afloat and for safety reasons, the priority equipment (bilge pump, fire protection and alarm equipment) keep on operating even when you switch the power off.



- When you leave the boat, use the on/off switches on the battery control panel to switch off power supply from the batteries to the equipment on your boat.
- When you return to the boat, use the on/off switches on the battery control panel to switch on the power supply.

### Related information

[4.2.6 Battery control panel](#) on page 43

#### 5.1.2 Fuses

The front cabin fuse panel on your boat contains separate fuses for the 12 V battery power and for the 110 V or 230 V shore power.

#### NOTICE

Risk of short circuit, overcurrent and damage to the equipment.

Make sure the amperage of the connected appliances does not exceed the amperage marked on the fuse.

Make sure the equipment and appliances on your boat are intact and properly connected.

- The 12 V fuses are connected to the different equipment and functions on your boat, such as lights, side terraces, radar, autopilot and water pumps.
- The main supply fuses are connected to the fridges and batteries.
- The priority fuses are connected to the priority equipment: bilge pump, fire protection and navigation lights. These systems require constant power supply. The systems stay on even when you switch off the power supply to the other equipment from the battery control panel when you leave the boat unattended.



The smoke detector and the carbon monoxide detector have their own batteries as a backup in case of a power failure.

- The direct supply fuses have several different functions:
  - Fuses D\_F3 and DF\_4 serve as the fuse and the main switch to the heater
  - Fuse D\_F2 serves as the main fuse for the priority equipment that require constant power supply
  - Fuse D\_F1 is a spare fuse for optional, additional equipment that requires constant power supply
- The shore power 110 V or 230 V fuses are connected to the battery charger, inverter, power outlets, electrical cooktop and air-conditioner unit. In addition, the shore power fuses protect these devices from an overcurrent fault.

### Related information

[4.2.5 Fuse panel](#) on page 42

[4.2.6 Battery control panel](#) on page 43

#### 5.1.2.1 Resetting tripped fuses

There are two types of fuses on your boat. Each type indicates the tripping differently and need to be reset differently.

When a 12 V DC fuse is tripped:

- The fuse button is up

When a 110 V / 230 V AC fuse is tripped:

- The switch in the fuse is down
- The indicator in the fuse is green

**⚠ CAUTION** Risk of electric shock or damage to the equipment.

Before you reset the fuse, find out why it has tripped.





1. Reset the fuse:
  - Press the button of the 12 V DC fuse down.
  - Flip the switch of the 110 V / 230 V AC fuse up. The indicator in the fuse turns red.
2. Check that the equipment or appliances connected to the fuse work properly. If the problem persists, contact a qualified nautical electrician.

#### Related information

[4.2.5 Fuse panel](#) on page 42

### 5.1.3 Batteries

The batteries give your boat 12 V DC power when used offshore.

#### WARNING

Risk of electric shock, battery overheating, explosion, fire or harmful gases.

Do not block the battery ventilation.



You can monitor the power use and the battery capacity from the CZone application on the chartplotter.

There are several batteries on your boat, depending on the level of equipment you have chosen.

In the aft technical compartment:

- Two engine batteries power up the engines on your boat. Each engine has its own battery.
- The service battery powers up the other equipment on your boat.
- The battery pack of the optional generator replacement system can include one or two batteries, depending on your options.

In the cabin technical compartment (under the bed in the front cabin):

- The auxiliary battery powers up the bow thruster and the anchor winch

Check the battery manufacturer's manual for more details/information about the batteries and their maintenance.

#### Related information

[4.2.5 Fuse panel](#) on page 42

[4.2.6 Battery control panel](#) on page 43

#### 5.1.3.1 Charging batteries

The batteries charge automatically when the engine is running or when your boat is connected to the shore power.

**⚠ WARNING**

Risk of electric shock, battery overheating, explosion, fire or harmful gases.

Do not use external charger on the boat.



- If there is a problem with the battery charging, call a qualified nautical electrician.

## 5.1.4 Shore power

When onshore, you can run your boat's equipment and charge the batteries with the 110 V or 230 V alternative current (AC) shore power.

The shore power saves you fuel as you do not need to run your engines to charge the batteries.

You can connect your boat from an external power source on shore to the shore power inlet on your boat with the shore power cable.

The shore power panel includes the **Reverse polarity** indicator, which alerts you if the polarity of the shore power source does not match your boat.



Inspect the electrical system at least twice a year and check the overcurrent protection / residual current device (RCD) every month.

### Related information

[4.2.7 Shore power panel](#) on page 44

### 5.1.4.1 Connecting shore power

Follow this procedure to connect the shore power cable to your boat.

**⚠ DANGER**

Risk of death, electric shock or injury.

Connect the shore power cable first to your boat and only then to the power supply onshore.

If you connect the cable in the wrong order and the live power cable comes into contact with water, people on board, nearby swimmers and marine life will be exposed to a potentially lethal electric shock.

**⚠ DANGER**

Risk of death, electric shock, injury or fire.

Do not alter shore power cable connectors. Use only cable connectors that are compatible with the shore power inlet on your boat and shore power receptacles.

Disconnect the shore power connection when the system is not in use.

**NOTICE**

Risk of damage to the electrical equipment on board.

Check the reverse polarity indicator on the shore power panel of your boat to make sure the polarity of the power source onshore matches your boat.



1. Check that the shore power main switch / overcurrent protection switch on the fuse panel is switched on.
2. Check that the shore power cable is intact.
3. Connect the shore power cable first to the inlet on the shore power panel on your boat and then to the power source at the dock.
4. Check that the **Reverse polarity** indicator on the shore power panel on your boat is green.
  - If the **Reverse polarity** indicator is red, disconnect the shore power cable immediately.
  - Contact the shore power service provider to correct the polarity issue before re-connecting the shore power.
5. Check that the shore power indicator on the fuse panel on your boat is red.
  - If the indicator light is off, disconnect the shore power cable and find out the reason for the failed connection before proceeding.
6. Disconnect the shore power cable first from the shore power source and then from the shore power inlet on your boat.
7. Check that the shore power indicator in the fuse panel is off.

**Related information**

[4.2.5 Fuse panel](#) on page 42

[4.2.7 Shore power panel](#) on page 44

## 5.1.5 Generator replacement system

The optional generator replacement system gives you extended use of 110 V or 230 V power to run the electrical appliances and equipment on your boat when you have no access to shore power.

The generator replacement system is located in the aft technical compartment. The system consists of a high-capacity 500 Ah battery pack (can be expanded to 1000 Ah) and a charger / inverter unit. Depending on your choice of equipment, the optional shore power can be used to charge the battery pack of the system.

You can monitor the charge level of the battery pack and the status of the generator replacement system with the CZone application on the chartplotter.

It is important to monitor the charge level, since the bilge pumps run on the battery pack power. If the charge level of the battery pack of the generator replacement system runs too low, or if there is a fault in the system, the system shuts itself down automatically. When shutting down, the safety relay switch of the battery pack switches automatically to the OFF position and the bilge pumps shut down, too.

Check the manufacturer's manuals for details of the components of the generator replacement system.

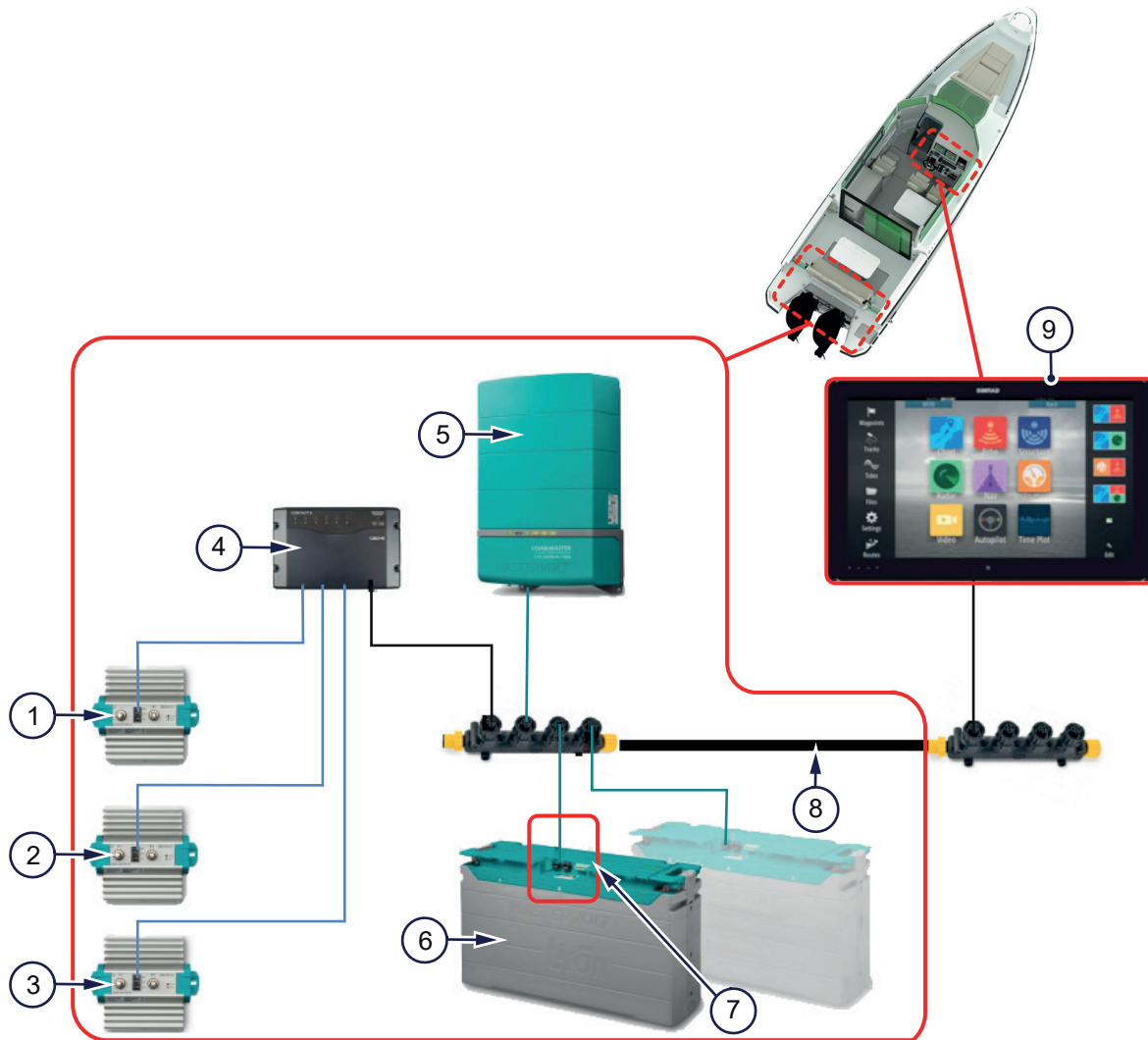

Figure 5.2 - Generator replacement system as a part of the power package system

- |   |   |   |   |
|---|---|---|---|
| 1 | Service battery isolator                        | 6 | Generator replacement system battery pack (+ extension) |
| 2 | Engine battery isolator                         | 7 | Safety relay switch of the battery pack                 |
| 3 | Auxiliary battery isolator                      | 8 | NMEA network  |
| 4 | Battery control unit                            | 9 | CZone application on the chartplotter                   |
| 5 | Generator replacement system charger / inverter |   |   |

**Related information**

[4.2.5 Fuse panel](#) on page 42

### 5.1.5.1 Using the generator replacement system and backup power supply

Normally, you do not need to do anything else about the generator replacement system but keep an eye on the charge level of the battery pack with the CZone application, charge the battery pack before the charge level is too low, and connect the backup power supply if needed to keep the bilge pumps running.



- If the charge level of the battery pack gets too low, or if there is a fault in the generator replacement system, the system shuts itself down.  
The bilge pumps shut down, too. The CZone application shows the shut-down status of the generator replacement system.
- If you have not noticed the shutting down early enough, the bilge water keeps accumulating. If the bilge water gets too high, the buzzer of the high bilge alarm gives a warning sound.
- Connect the backup power supply immediately to activate the bilge pumps: press the **Power source transfer switch** on the fuse panel.  
The battery of the starboard engine starts serving as the backup power supply to the bilge pumps. Other equipment get the power from their dedicated batteries.
- Switch the safety relay switch of the battery pack to ON position to enable charging of the battery pack.
- Run the engines to charge the battery pack and the other batteries on your boat, or connect the shore power if possible.

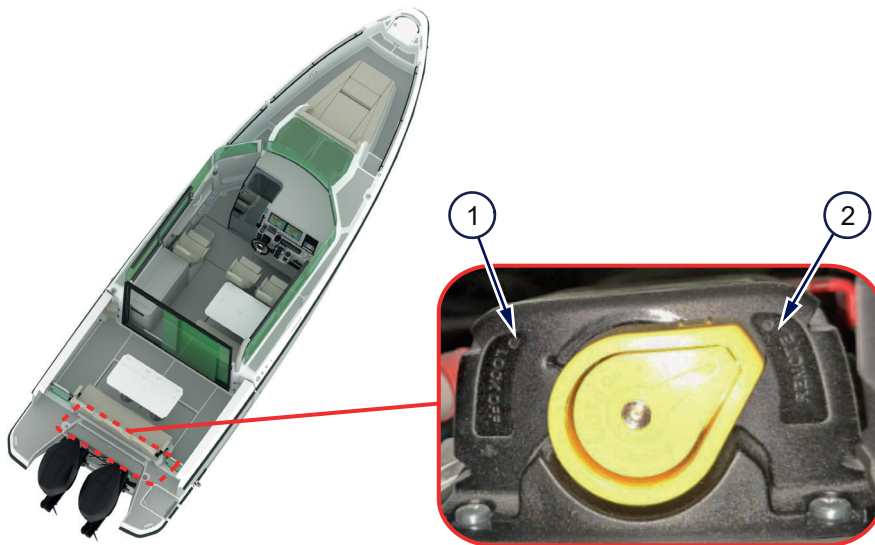

Figure 5.3 - Battery pack safety relay switch ON / OFF

- 1 Safety relay switch in OFF position
- 2 Safety relay switch in ON position

#### Related information

[4.2.5 Fuse panel](#) on page 42

## 5.2 Engine and steering system

You can steer the boat and control the engines, trim tabs and bow thruster from the helm station controls.



Figure 5.4 - Engine and steering

1	Engine(s)	3	Engine, trim tabs and bow thruster controls
2	Trim tabs	4	Bow thruster

### Learn more

- How to use the engine controls, lanyard stop switch and how to trim your boat: [3.2 Driving and steering on page 22](#)

### Related information

[4.2.1 Helm station controls on page 35](#)

### 5.2.1 Engine

The engine on your boat is a powerful, industry-leading outboard engine.

Before using the engine, check the engine manufacturer's manual for more detailed instructions for use and maintenance.

You can check your boat's engine model and serial number from the label on the engine. See Technical specification for the make and type of the engine(s) on your boat.

#### NOTICE

Risk of damage to the hull or engine fixing points.

Do not exceed the maximum engine power shown on your boat's builder's plate.

### 5.2.1.1 Starting the engine

Read the engine manufacturer's manual before starting the engine.

**NOTICE**

Neglecting the break-in period for a new engine may cause engine damage or result in poor engine performance.

For instructions for breaking in the engine as well as other more detailed instructions for using the engine, check the engine manufacturer's manual.



1. Before starting the engine, make sure there are no fuel or oil leaks and there is enough fuel in the tank.
2. Turn on the main switch.
3. Set the lanyard stop switch to the RUN position.
4. Check that the gear shift is in neutral.
5. Start the engine as described in the engine manufacturer's manual. If your boat has two engines, make sure to start them both.

### 5.2.2 Trim tabs

You can use the trim tabs to control the running angle of your boat. The optional Active Trim system handles the trimming process automatically.

**Learn more**

- About the basics of trimming and the trim tabs on your boat: [3.2 Driving and steering on page 22](#)

### 5.2.3 Bow thruster

A bow thruster provides lateral thrust and thus makes your boat easier to maneuver when docking and undocking.

The bow thruster shuts off automatically in 6 to 9 minutes after last use. Check the bow thruster manufacturer's manual for more details.

## 5.3 Fuel system

Your boat's engines run on gasoline. The optional heater system is powered by diesel fuel.

**⚠ WARNING**

Hot engine parts could cause a fire if in contact with flammable materials.

Store equipment that contains gasoline only in compartments designed for this purpose.

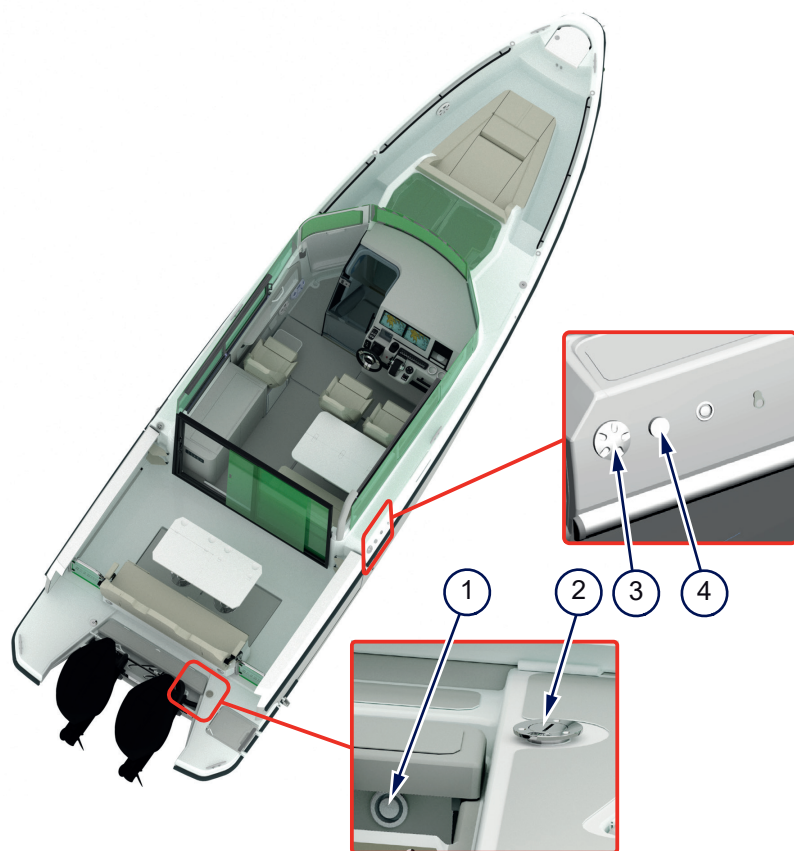

Figure 5.5 - Fuel system

- |   |                                 |   |                                   |
|---|---------------------------------|---|-----------------------------------|
| 1 | Diesel tank ventilation opening | 3 | Gasoline fuel filling inlet       |
| 2 | Diesel fuel filling inlet       | 4 | Gasoline tank ventilation opening |

You can monitor the fuel level in the tanks on the chartplotter display. Always use high-quality gasoline that meets the requirements stated in the engine manufacturer's manual.

**⚠ CAUTION** Risk of fire, explosion or material damage.

Avoid damaging the fuel lines on your boat. Pay attention to the location and condition of the fuel lines.

Check the engine and heater manufacturer's manuals for more information on:

- Instructions for use and care
- Detailed refueling instructions
- Suitable fuel types

#### Learn more

- How to minimize risk of fire: [2.5.3 Don't play with fire](#) on page 16



## 5.4 Draining system

Your boat's draining system consists of an automatic bilge pump system with three electric bilge pumps, a manual bilge pump and a cockpit draining system with drain holes for rain water and wave splashes.



The draining system is not foolproof! The bilge pump system is not designed to pump out large amounts of water.

See the bilge pump manufacturer's manuals for instructions on how to use and maintain the pumps.

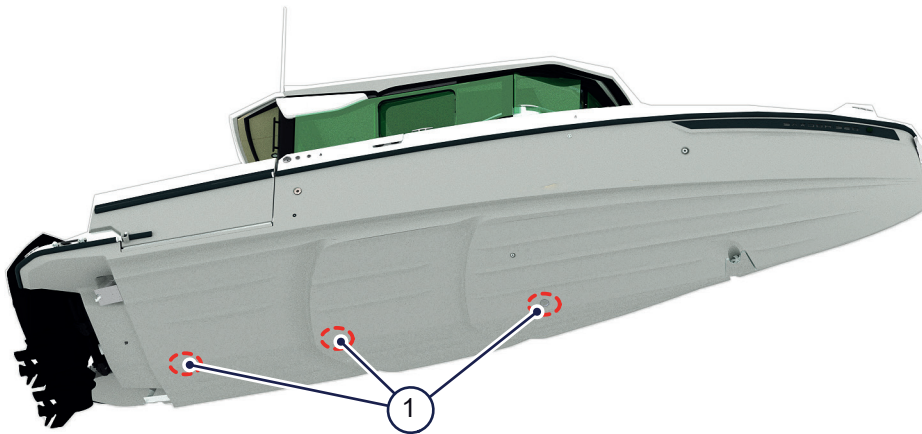

Figure 5.6 - Automatic bilge pumps

- 1 Automatic bilge pumps

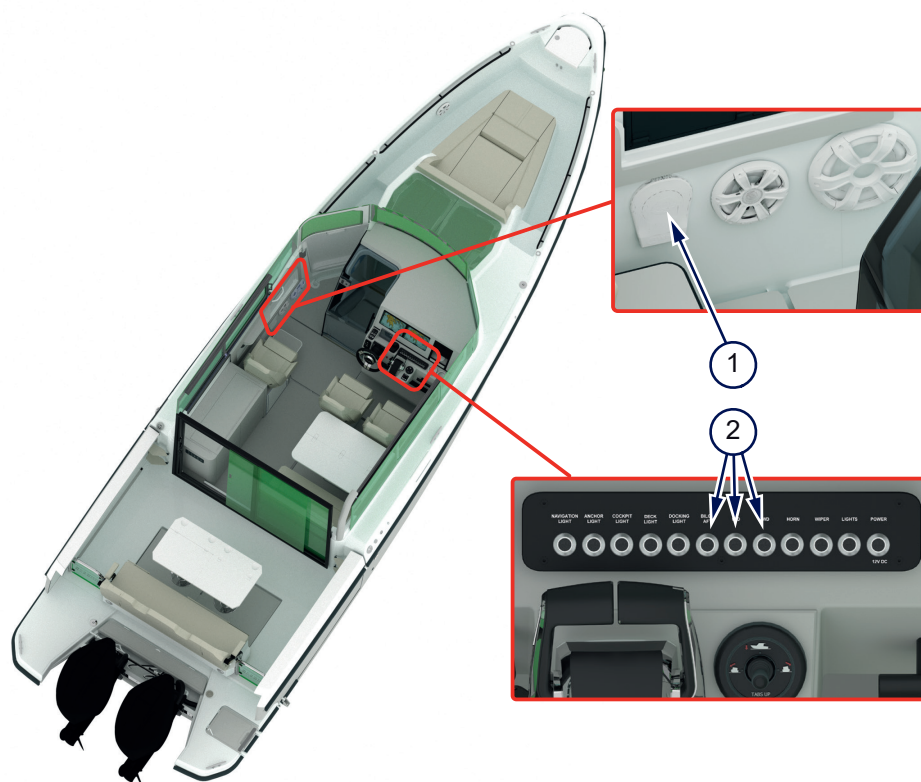

Figure 5.7 - Manual bilge pump and automatic bilge pump controls

- 1 Manual bilge pump
- 2 AFT, MID and FWD bilge pump controls

### Learn more

- How to ensure stability: [2.5.1 Avoid flooding and capsizing](#) on page 15

### Related information

[4.6.3 Hull openings](#) on page 58

## 5.4.1 Using bilge pumps

If there is water in the bilge, the automatic bilge pump system activates and pumps out any extra water buildup from the bilge. A manual pump is available as a backup if there is no electricity.

Normally, you don't need to do anything other than monitor the water buildup. The automatic bilge pumps detect water in the bilge and automatically pump out water when required.

You can also control the automatic bilge pump system from the Navigation and lighting control panel on the steering console. A light on the panel is lit when the pump is on.



- If water starts building up, start the pump from the panel manually if the automatic doesn't work. Use the manual pump if the automatic pump is out of order or out of power.

**WARNING**

The boat can sink if too much water gets into the boat.

If you suspect a leak, find out the reason and go ashore as soon as possible. The bilge pump system is not designed to pump out large amounts of water.

If there is a rapid increase in water accumulation, call rescue service.



To open the hatch of the aft technical compartment, use the **Technical hatch** open/close buttons in the side terrace control panel.

**Related information**

[4.2.1.1 Navigation and lighting control panel](#) on page 36

[4.2.3 Side terrace control panel](#) on page 40

## 5.5 Fresh and waste water systems

Your boat can be equipped with a fresh water system and a waste water system. Depending on your choice of equipment, the waste water system can consist of separate grey water and black water systems.

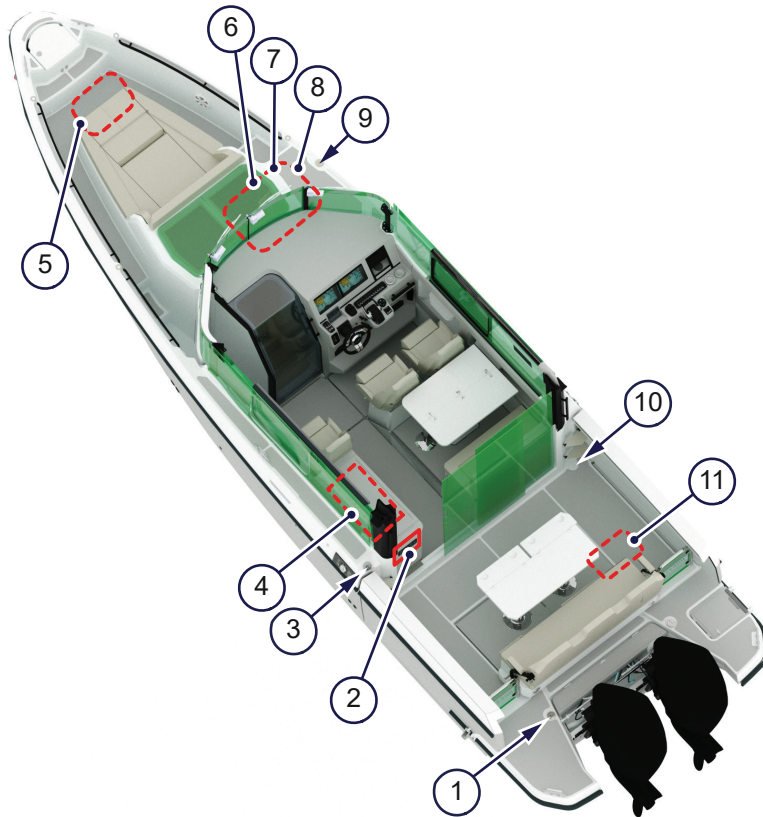

Figure 5.8 - Fresh, grey and black water systems

1	Fresh water filling inlet	7	Toilet and toilet compartment control panel
2	Side terrace control panel	8	Black water tank
3	Fresh water shower	9	Black water discharge outlet
4	Fresh water tap and sink in the wet bar	10	Grey water discharge outlet
5	Fresh water tank	11	Grey water tank
6	Fresh water tap, bidet shower and sink in toilet compartment		

The fresh, grey and black water systems have each their own plumbing and tanks.

- The fresh water system provides water to the shower on the bathing platform, to the bidet shower in the toilet compartment, and to the taps in the wet bar and in the toilet compartment.
- The grey water system collects waste water from the sinks in the toilet compartment and wet bar. In addition, the grey water system collects the condensation water from the optional air conditioning equipment.
  - The grey water runs from the sinks to the holding tanks below the sinks. To ensure the grey water system keeps working properly, use the **Grey water pump** button on the toilet compartment

control panel or on the side terrace control panel regularly to pump the grey water from the holding tanks to the separate grey water tank.

- The black water system collects the waste water from the toilet.
- The toilet operates with electricity or manually, depending on your choice of equipment. The electrical toilet uses fresh water for flushing, and the manual toilet uses sea water or lake water for flushing.



When you leave the boat unused for a longer period of time or store the boat over winter, the fresh and waste water systems will build up bacteria and impurities, or will freeze in cold weather. Before you leave or store your boat, empty the fresh and waste water systems and tanks and flush them with fresh water.

### 5.5.1 Using the fresh water system



- Fill the fresh water tank from the filling inlet marked with the text **Water**. To ensure you will always have enough fresh water, top up the tank whenever you have the chance.
- If the water pressure is low, press the **Fresh water pump** button on the toilet compartment control panel to switch on the fresh water pump. The **Fresh water pump** button is also available on the side terrace control panel. The pump switches off automatically when the system has generated enough water pressure.
- To prevent a build-up of bacteria and impurities, empty, flush and refill the tank with fresh water at regular intervals.

#### Related information

[4.2.2 Toilet compartment control panel](#) on page 39

[4.2.3 Side terrace control panel](#) on page 40

### 5.5.2 Using the toilet

You can flush the toilet electrically or manually, depending on the equipment you have chosen.



- Press the **Toilet flush** button in the toilet compartment control panel to flush.
- If you are using the manual flush, open the seacock tap before flushing, and close it afterwards.

#### Related information

[4.2.2 Toilet compartment control panel](#) on page 39

### 5.5.3 Emptying the waste water tanks

Always empty the grey and black water tanks into the fixed waste water tanks onshore.

**⚠ CAUTION**

Pollution and health hazard.

Do not empty the waste water tanks into the water.

Plan your voyage in a way that you can always reach shore with proper fixed waste water tanks in good time before your waste water tanks get filled.



1. Use the **Grey water pump** button on the toilet compartment control panel to pump the grey water from the holding tanks to the grey water tank.
2. Make sure the seacocks in the grey and black water openings on your boat are closed tightly.
3. Connect the suction hose from the shore tank to your boat's grey water or black water discharge outlet marked with the text **Waste**.
4. Turn on the waste water pump of the shore tank.
5. Hold the suction hose tightly in place in the discharge outlet during the whole emptying process to prevent any accidental spilling onto the deck or water.
6. When the grey water tank or the black water tank is empty, shut off the waste water pump on the shore.
7. Disconnect the suction hose from the discharge outlet on your boat and close the outlet lid tightly.

**Related information**

[6 Respect the environment](#) on page 89

## 5.6 Navigation equipment

Your boat is equipped with the navigation equipment of your choice. See the equipment manufacturers' manuals for details for instructions for their use.

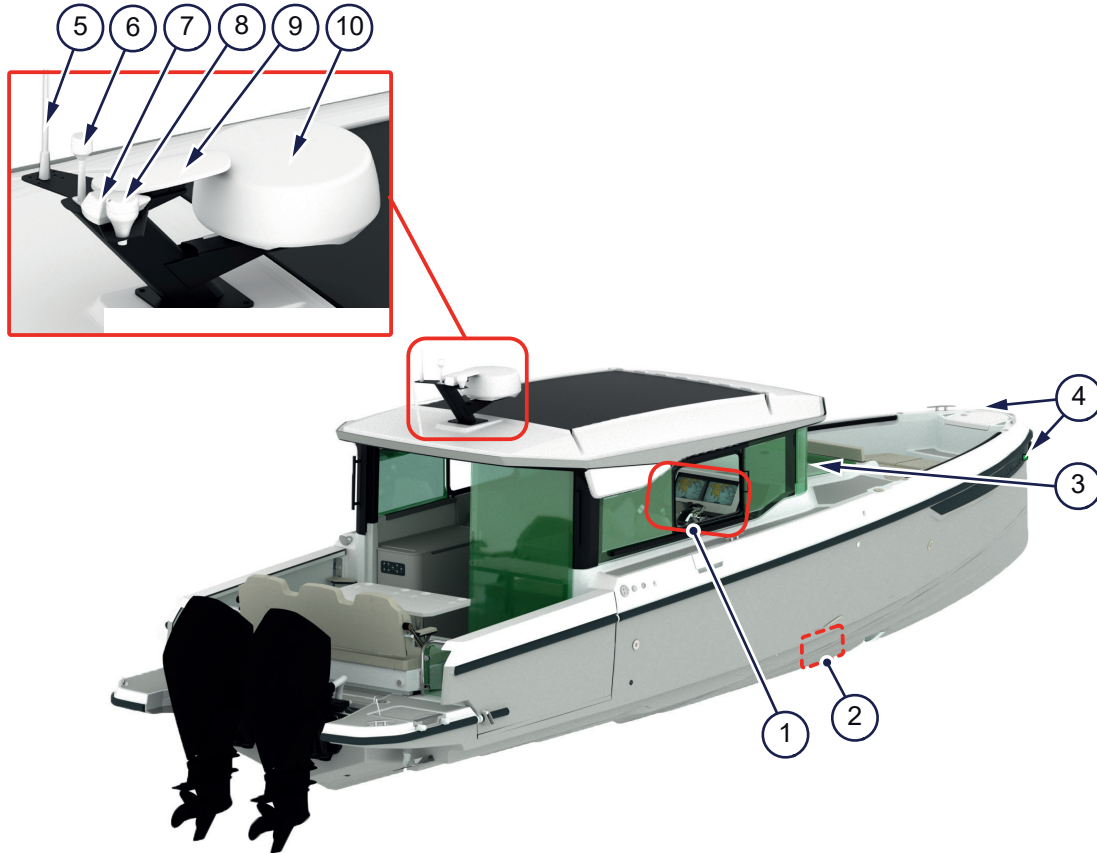

Figure 5.9 - Navigation equipment

- |   |                               |    |                                 |
|---|-------------------------------|----|---------------------------------|
| 1 | Navigation equipment controls | 6  | Anchor light                    |
| 2 | Echosounder transducer        | 7  | Horn                            |
| 3 | Windshield wiper              | 8  | GPS antenna                     |
| 4 | Navigation lights             | 9  | Satellite compass for autopilot |
| 5 | VHF+AIS antenna               | 10 | Radar dome                      |

### Navigation lights, horn and windshield wiper

Your boat is equipped with LED navigation lights, anchor light, horn and windshield wiper. You can find the control buttons for all these equipment on the helm station.

### Chartplotter displays

You can control the following navigation equipment via the chartplotter displays on the helm station:

- Chartplotter
- Echosounder

- Radar
- Autopilot

**VHF and AIS**

The VHF radio and AIS controls are available on the integrated VHF and AIS handset on the helm station.

**Related information**

[4.2.1 Helm station controls](#) on page 35

**5.7 Anchor system**

You can lower and lift the anchor with the electrical anchor winch, or you can use the anchor manually.

**CAUTION**

Risk of injury or material damage.

Always lift the anchor up and secure it in the anchor box or lock it in the retaining system when you are not using the anchor.

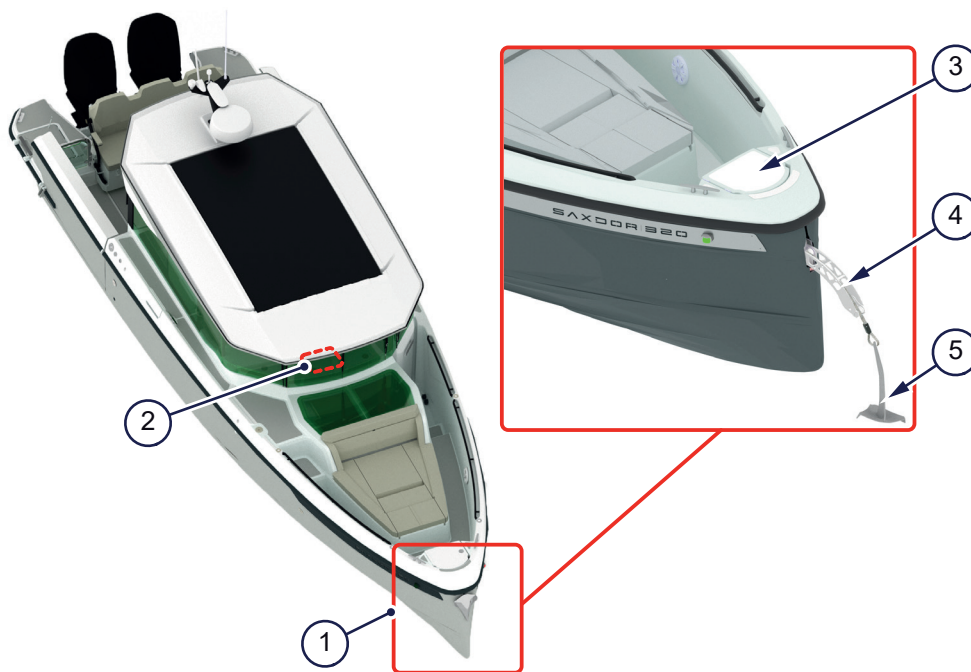

Figure 5.10 - Anchor system

- |   |                            |   |                |
|---|----------------------------|---|----------------|
| 1 | Anchor lifted              | 4 | Anchor roller  |
| 2 | Anchor winch control panel | 5 | Anchor lowered |
| 3 | Anchor box                 |   |                |



The anchor on your boat is located either in the anchor box, or in the optional electrical anchor retaining system under the anchor box. The retaining system consists of the electrical anchor winch and other components of the lifting/lowering mechanism, such as the anchor roller.

When you lower or lift the anchor electrically, the anchor roller extends from the bow and guides the anchor far enough from the bow so that the anchor and the anchor wire do not touch the bow and damage it.

### Learn more

- About anchoring and anchor chains: [3.3 Mooring, towing and anchoring](#) on page 25

### Related information

[4.2.1.2 Anchor winch control panel](#) on page 37

## 5.8 Comfort and fun

Find out here what fun and comforts your boat offers offshore, and how to protect the boat's interior and surfaces when in dock.

### 5.8.1 Heating and air-conditioning

The optional heating and air-conditioning system keeps you warm at night and cool by day.

#### **WARNING**

Risk of fire or carbon monoxide accumulation.

Do not block the heater's exhaust pipe, ventilation or warm air outlet.

You can operate the heating and air-conditioning from the temperature control panel.

The air-conditioning unit takes water for the cooling circuit from the sea or lake through a hull opening. The condensate water from the air-conditioning system runs into the grey water tank.

The heater operates on diesel fuel.

Check the manufacturer's manual of the heating and air-conditioning system for more details about using the equipment.

### Related information

[4.2.9 Temperature control panel](#) on page 46

[4.6.3 Hull openings](#) on page 58

[5.3 Fuel system](#) on page 71

[5.5 Fresh and waste water systems](#) on page 76

## 5.8.2 Wet bar

The wet bar offers you full cooking facilities when onboard.

**⚠ WARNING**

Risk of fire or overheating.

Do not close the lid of the wet bar when the cooktop is hot.

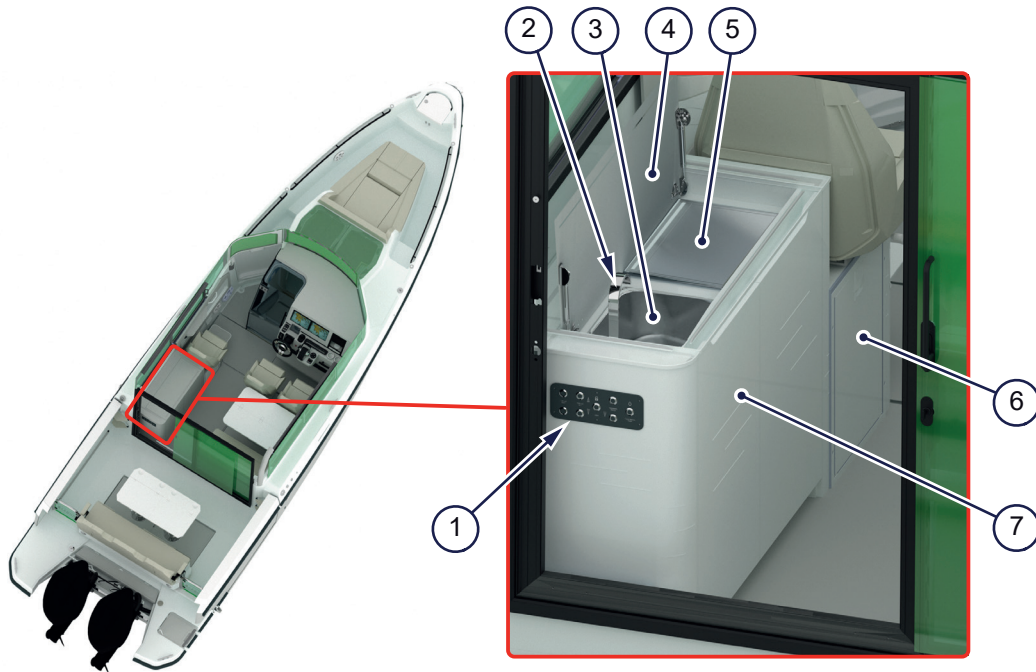

Figure 5.11 - Wet bar

- |   |                            |   |   |
|---|----------------------------|---|---|
| 1 | Side terrace control panel | 5 | Cooktop   |
| 2 | Fresh water tap            | 6 | Fridge (optional second fridge under the main cabin sofa) |
| 3 | Sink                       | 7 | Cupboards   |
| 4 | Wet bar lid                |   |   |

Cooking is quick and efficient with the cooktop on the wet bar.

Depending on your choice of equipment, you can power up your cooktop like this:

- The electrical induction cooktop operates with shore power and with the battery capacity of the generator replacement system
- The diesel-powered cooktop operates with diesel fuel



For safety and hygiene reasons, close the lid when the cooktop has cooled down and when you are not using the wet bar.



It is a good idea to keep an eye on the battery capacity when cooking, and charge the battery when necessary. The cooktop is quick to drain the battery.

The fresh water tap and sink provide fresh water for cooking and doing the dishes.



If the water pressure is low, use the **Fresh water pump** button on the side terrace panel control panel or on the toilet compartment control panel to switch on the fresh water pump.

The fridges have their temperature control and on/off switches inside the fridge.

### Related information

[4.2.2 Toilet compartment control panel](#) on page 39

[4.2.3 Side terrace control panel](#) on page 40

[4.2.8 Cooktop control panel](#) on page 45

[5.5 Fresh and waste water systems](#) on page 76

## 5.8.3 Seating

Your boat offers different areas and setups for seating.

Your boat is equipped with two cockpit seats in the main cabin: one for the driver and one for the front passenger. You can rotate and move the cockpit seats back and forth and lock / unlock the seat from the locking handle.

### WARNING

Risk of death or serious injury.

Failure to lock the seat can cause you to be ejected from the seat.

Lock the cockpit seat when you drive.

Other seating setups:

- In the main cabin: a sofa by an adjustable table and an additional passenger seat. The sofa and the passenger seat have no adjustment possibilities. You can lower and lift the table electrically.
- On the aft deck: a sofa by an adjustable table. You can lower and lift the table manually.
- On the foredeck: a sun bed with removable cushions

### Related information

[4.5.2 Safe seating and moving areas](#) on page 49

## 5.8.4 Side terraces

The folding side terraces on both sides of the aft deck of your boat allow you to extend your offshore life onto a whole new level.

### **⚠ WARNING**

Risk of injury, falling overboard or material damage.

Make sure there are no people or objects near or on the side terraces when you lower or lift them. Always lower the side terrace to the lowest locking position.

Lift the side terraces before you move the boat. It is prohibited to drive the boat unless the side terraces are locked in upright position.

### **⚠ CAUTION**

Risk of boat tipping or side terrace breaking down, risk of people or property falling into the water.

Always remember the balance of the boat and the durability of the side terrace.

Do not allow too many people to stay on the lowered side terrace.

Do not place too much load on the lowered side terrace.

Do not exceed the maximum permitted load on the side terraces. Check the technical specification for the maximum permitted load.

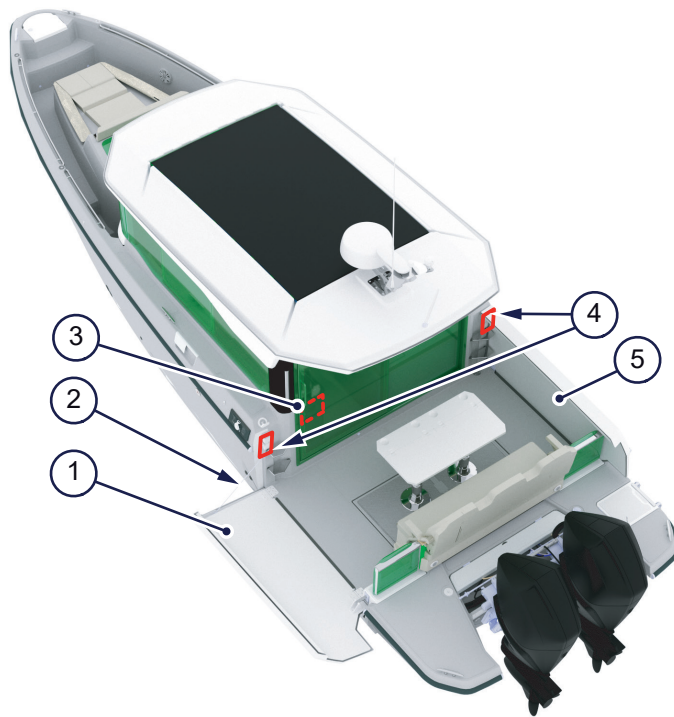

Figure 5.12 - Side terraces

- |   |   |   |   |
|---|---|---|---|
| 1 | Folding side terrace in the lowest locking position | 4 | Side terrace latches                                |
| 2 | Side terrace securing wire                          | 5 | Folding side terrace locked in the upright position |
| 3 | Side terrace control panel                          |   |   |

You can lower and raise each side terrace separately from the side terrace control panel.

- Mechanical latches keep the folding side terraces locked in the upright position when you drive.
- When you lower the side terrace to the lowest locking position, the securing wire is straight and tight to show the proper position, and serves as a safety mechanism, as well. This ensures the terrace does not give way under your foot and cause you or your guests to fall into the water.

### Related information

[4.1.4 Aft deck](#) on page 32

[4.2.3 Side terrace control panel](#) on page 40

### 5.8.4.1 Using the side terraces

You can lower and raise each folding side terrace separately.

1. Unlock the side terrace latches.  
If you want to lower just one terrace, unlock the latch for that terrace only.
2. Lower the terraces from the side terrace control panel.  
Press the locking button **Lock** and the arrow button of the port terrace or starboard terrace (**Terrace PORT** or **Terrace STB**) at the same time.



3. Lower the terraces to the lowest locking position so that the securing wire is straight and tight. The electric motor of the terrace mechanism stops automatically when the terrace is in the lowest locking position.
4. When you want to raise the side terraces, press the **Lock** button and the **Terrace PORT** or **Terrace STB** arrow button at the same time. The electric motor of the terrace mechanism stops automatically when the terrace is in the upright locking position.
5. Lock the side terrace latches.

#### Related information

[4.2.3 Side terrace control panel](#) on page 40

### 5.8.5 Sun shade

The sun shade keeps you and your passengers cool when the boat is stationary.

**⚠ CAUTION** Risk of injury or material damage.

Do not drive the boat when the sun shade is up. The sun shade and mounting poles may tear off.

Do not use the sun shade in harsh weather conditions and in strong wind.

You can set up, attach and lock the sun shade to the mountings on the foredeck.

### 5.8.6 Water ski pole

The water ski pole offers you a safe way to do water sports.

**⚠ WARNING** Risk of serious injury or material damage.

The water ski pole and its mounting may tear off and cause damage and injury.

Use the pole only for water skiing. Do not use it for towing other boats, vessels or water toys.

**⚠ CAUTION** Risk of injury or material damage.

Do not attach the water ski rope to cleats or other parts of the boat.

Attach and lock the water ski pole to the mounting on the bathing platform.

## 5.8.7 Bathing ladder

The bathing ladder on the bathing platform allows swimmers to go into the water and reboard safely and unattended. In addition, it is a safe way to rescue people from the water.

**⚠ WARNING** A rotating propeller may cause death or a serious injury.

Shut off the engine when there are people in the water near the boat.

Do not reboard the boat when the engine is running.

Do not use the engine's cavitation plates for reboarding the boat.

**⚠ CAUTION** Risk of injury or material damage.

Do not lock or block the bathing ladder hatch.

Do not drive the boat when the bathing ladder is down.

The ladder is secured in place under the bathing ladder hatch. The bathing ladder is easy to pull out from the hatch and extend even when you are in the water.

### Learn more

- How to rescue people from the water: [2.6.2 Man overboard!](#) on page 19
- Where the bathing ladder is located: [4.1.5 Bathing platform](#) on page 33 and [4.6.4 Hatches](#) on page 59

## 5.8.8 Harbor covers

When you store your boat for the off-season, protect the seats and other surfaces from the sun, rain and dirt with harbor covers.

**⚠ CAUTION** Risk of injury or material damage.

Do not use the harbor covers when driving. The covers may tear off in strong wind.

When storing the boat, attach the harbor covers to the channels underneath the T-Top and to the windshield frame.

## 5.8.9 Lighting and audio

### Lighting

Your boat is equipped with LED lighting in the front cabin, on the cockpit and on the deck. You can adjust cockpit and deck lights from the control panel at the helm station.

## Audio

Depending on the options you choose, your boat can be equipped with a Hi-fi audio system with the audio device, amplifier, subwoofer and speakers.

Check the audio equipment manufacturer's manuals for more information on the features and the use of the equipment.

## Related information

[4.2.1.1 Navigation and lighting control panel](#) on page 36



## 6 Respect the environment

As the proud captain of a Saxdor boat, you have the responsibility to protect the marine environment. Ensure that you and your crew comply with the environmental laws like the International Convention for the Prevention of Pollution from marine vessels (MARPOL) and the local regulations in the area where you are boating.

### 6.1 Handling waste properly



Follow these tips to ensure you are handling your boating waste properly.

- Never throw garbage or waste into the sea or on the shore.
- Never pour down sink substances that are harmful to the environment - even if your boat had a grey water tank that ensures that water does not drain directly into the sea from the sink.
- Never pump dirty bilge water into the sea. For dirty bilge water, use a separate container and dispose of it as hazardous waste.
- Check the bilge water regularly for contaminants like oil, diesel, or glycol.
- Do not empty the waste water tanks into the sea. Constantly monitor the level of your waste water tanks and plan your trip so that you can always empty the tanks at port.

### 6.2 Avoiding contaminant spills



Follow these tips to avoid contaminant spills.

- Take care not to spill fuel, oil, detergents or solvents into the sea. Keep oil absorbent material on board at all times in case of a spill or leakage.
- Do not overfill the fuel tank. Make sure fuel does not overflow into the sea from the fuel ventilation opening.
- When caring for your boat, do not use substances harmful to the environment. Follow the local regulations concerning acceptable cleaning agents, waxes and paints.

### 6.3 Minimizing emissions and disturbance



Follow these tips to minimize emissions and disturbance when boating.

- Have the engine and propeller serviced by an authorised professional.
- Adjust your speed to avoid disturbance and shoreline erosion caused by waves that your boat creates.
- To reduce fuel consumption and to avoid disturbing others, do not idle or rev the engine unnecessarily.
- Do not load your boat with unnecessary items as extra weight uses more fuel.
- Keep the hull of your boat clean to reduce the amount of drag.
- Maintain the optimal trim of the boat as it affects the fuel consumption.

## 6.4 Preventing the spreading of aquatic invasive species

Follow these tips to prevent the spreading of harmful watercraft-borne marine life.

The American Boat and Yacht Council (ABYC) has classified certain species of marine life as harmful aquatic invasive species (AIS). These species are plants, animals and microbes which can attach themselves to your boat or to your trailer, or which can find their way to the water systems or water deposits on your boat.



- Take necessary precaution when moving between different bodies of water to prevent the spreading of the AIS.
- Take necessary purification measures for your boat to eradicate the AIS.

The purification measures include (but not limited to) physical cleaning, draining and drying, as well as decontamination of the surfaces and water systems or water deposits on your boat.

- Contact your Saxdor dealer for more information about the prevention of the AIS.

## 7 Care for your boat

To ensure safety and the validity of your boat's warranty, have the boat regularly and professionally maintained and serviced.



Saxdor Yachts cannot be held responsible for modifications not approved by the company.

Always use trained and competent people for maintenance, repair or modifications.

Modifications that may affect the safety characteristics of the boat need to be assessed, executed and documented by competent people.

Contact your Saxdor dealer for information about authorized boat service providers.

Make sure your Saxdor dealer has registered the engine and other third party equipment on your boat with the equipment manufacturers to activate warranty. Warranty registration helps you in any service related issues with the equipment.

## 8 The details

Check here the relevant number information for your boat.

This information is handy when planning and provisioning for your next trip, and on the way, too.

### 8.1 Technical specification

Table 8.1 - General specifications

Description	Value
Boat model	Saxdor 320 GTC (Main cabin model)
Purpose of the boat	Recreational
Engine	Mercury 300 twin outboard engines
Maximum recommended engine power	522kW/ 700HP for twin outboard engines
Maximum speed	45 kn (with twin engines)
Recommended fuel for the engine	See the engine manufacturer's manual
Recommended fuel for the heater	See the heater manufacturer's manual
Maximum number of people on board	
• Design category B	6
• Design category C	9
Battery power DC system voltage	12 V
Shore power AC system voltage	110 V or 230 V
Breaking strength of strong points	50 kN

Table 8.2 - Weights

Description	Category B		Category C	
	kg	lb	kg	lb
Light craft condition ( $m_{LC}$ )	3603 kg	7943 lb	3940 kg	8686 lb
Maximum load on the builder's plate ( $m_{MBP}$ )	570 kg	1257 lb	725 kg	1598 lb
Full load	5446 kg	12006 lb	5615 kg	12379 lb
Tonnage <sup>1)</sup>	4300 kg - 4900 kg	9480 lb - 10803 lb	4300 - 4900 kg	9480 lb - 10803 lb

Description	Category B		Category C	
Weight of the maximum recommended number of people (included on the builder's plate) <sup>2)</sup>	450 kg	992 lb	675 kg	1488 lb
Luggage and other personal belongings (included on the builder's plate)	120 kg	265 lb	50 kg	110 lb
Inflatable life raft	66 kg	146 lb	80 kg	176 lb
Engine (recommended maximum)	638 kg	1407 lb	638 kg	1407 lb
Fuel	337 kg	743 lb	337 kg	743 lb
Fresh water	95 kg	209 lb	95 kg	209 lb
Grey water	47 kg	104 lb	47 kg	104 lb
Septic water	38 kg	84 lb	38 kg	84 lb
Total weight of liquids in fixed tanks when full	504.5 kg (+ 71 kg optional)	1112 lb (+ 157 lb optional)	504.5 kg (+ 71 kg optional)	1112 lb (+ 157 lb optional)
Weight of the boat when towed on a trailer ( $m_T$ ) <sup>3)</sup>	4725 kg	10417 lb	4725 kg	10417 lb
Margin for future additional equipment	542 kg	1195 lb	521 kg	1149 lb
Maximum permitted load on one side terrace	150 kg	331 lb	150 kg	331 lb
Maximum load condition	5298 kg	11680 lb	5333 kg	11757 lb
Loaded displacement mass <sup>4)</sup>	5446 kg	12006 lb	5615 kg	12379 lb

1) Depending on options

2) Calculated average: one adult equals 75 kg / 165 lb, one child 37.5 kg / 83 lb.

3) Items included in the  $m_T$  weight: structure, permanent internal and external equipment, engine, tanks and tank content.

Items not included in the  $m_T$  weight: loose internal equipment, loose electronic and navigational equipment (e.g. charts), tools, spare parts, personal safety and life-saving equipment, provisions, bilge water, bait tanks

4) Includes the weight of all persons onboard, all provisions and personal effects, any equipment not included in the light craft mass, cargo (if any) and all consumable liquids (water, fuel, etc.).

**Table 8.3 - Tank capacities**

Description	Value	
Gasoline (for engines)	428 L	113.1 gal
Diesel (for optional heater)	25 L	6.6 gal
Fresh water	110 L	29.1 gal

Description	Value	
Black water	55 L	14.5 gal
Grey water	50 L	13.2 gal

Table 8.4 - Bilge pump capacity

Description	Value	
Automatic	34 L/min	9.0 gal/min
Manual (45 strokes/minute)	32.75 L/min	8.7 gal/min

Table 8.5 - Lifting point locations

Dimension	Description	Value	
A	Minimum distance from the measuring point in the end of the keel to the lifting point in the bow	5.2 m	17.1 ft
B	Minimum distance from the measuring point in the end of the keel to the lifting point in the aft	0.75 m	2.5 ft

## 8.2 Boat dimensions

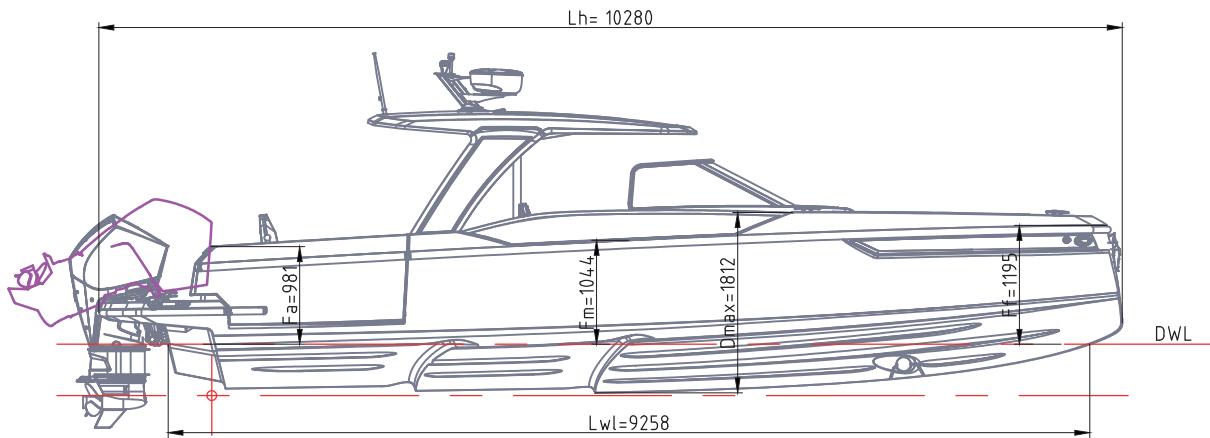

Figure 8.1 - Saxdor 320 GTC dimensions, side view

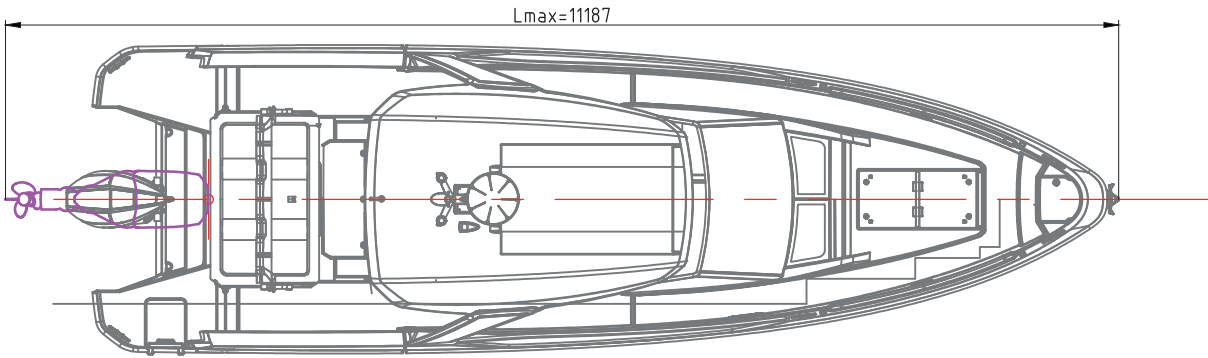

Figure 8.2 - Saxdor 320 GTC dimensions, top view

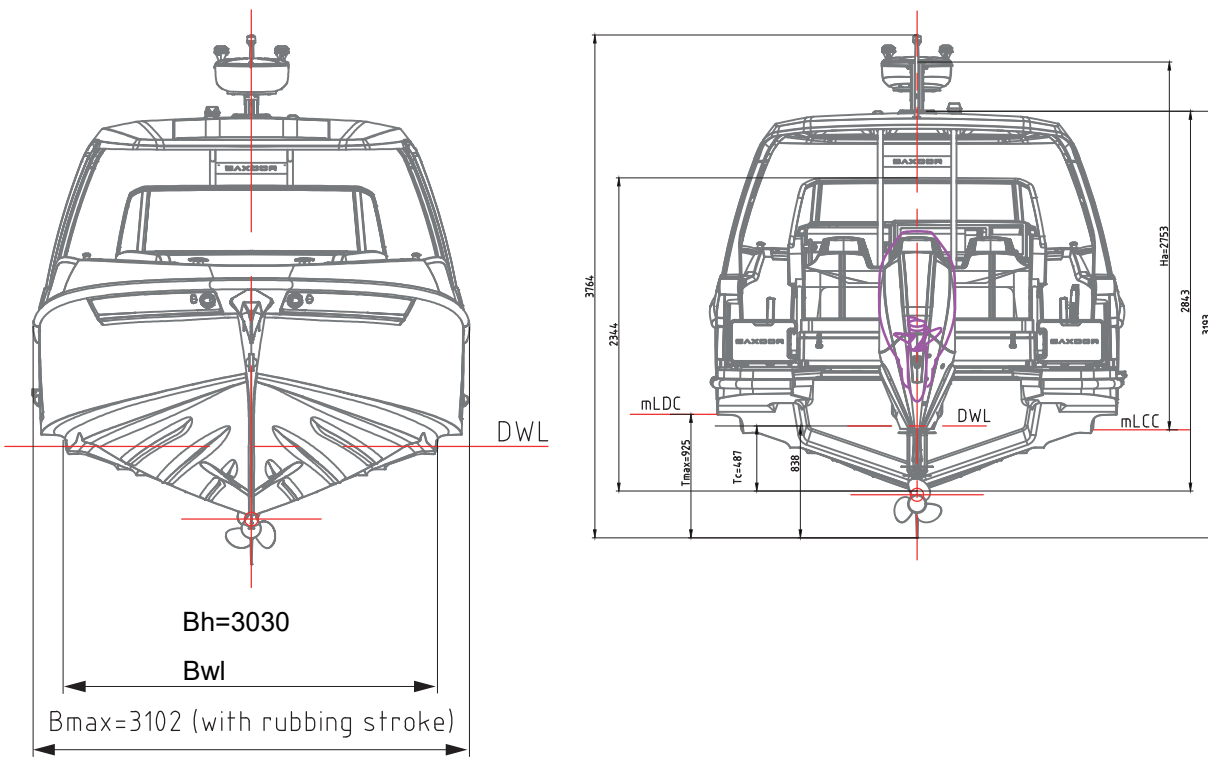

Figure 8.3 - Saxdor 320 GTC dimensions, bow and aft view

Table 8.6 - Description of dimensions

Dimension	Description	Value	
D <sub>WL</sub>	Design waterline		
H <sub>A</sub>	Air draft: the height from the waterline to the highest non-removable part of the boat (radar/antennas/lights on the T-Top)	2.74 m	8.99 ft
H	Overall height: the height from the bottom of the hull to the highest non-removable part of the boat	3.38 m	11.09 ft

Dimension	Description	Value	
L <sub>H</sub>	Overall hull length: the overall length of the hull from the bow to the end of the bathing platform	10.28 m	33.73 ft
T <sub>M</sub>	Hull draft: the measure from the waterline to the lowest part of the engine (the fin-like skeg that protects the propeller)	0.92 m	3.02 ft
T	Draft: the measure from the waterline to the bottom of the keel	0.49 m	1.61 ft
B <sub>H</sub>	Beam: the width of the boat	3.03 m	9.94 ft
B <sub>wl</sub>	Beam waterline	2.64 m	8.67 ft



## 9 Extras

Check here the relevant info about the warranty and qualification of your boat, as well links to the manufacturer's information about the different equipment on your boat.

### 9.1 Declaration of conformity

The declaration of conformity states that your boat meets all relevant requirements of all product safety directives applicable to the boat.

- You can find the declaration of conformity document in the Saxdor documentation bag.

### 9.2 Electrical wiring diagram

The electrical wiring diagram includes the drawings of all circuits and electrical connections on your boat.

- If you need a copy of the electrical wiring diagram, please contact your Saxdor dealer.

### 9.3 Warranty

The warranty states the guarantee of the integrity of your boat and the maker's responsibility of your boat.

- Check the warranty at [www.saxdoryachts.com](http://www.saxdoryachts.com).

### 9.4 Warnings and cautions

Heed all the warnings and cautions in this manual! For your convenience, they are also listed here.

**⚠ DANGER**

Risk of electric shock, fire or explosion.

Remember that water and electricity are a bad combination.

Let only a competent marine electrical technician carry out any installation, alteration or maintenance work to the electrical system.

**⚠ DANGER**

Risk of death, electric shock or injury.

Connect the shore power cable first to your boat and only then to the power supply onshore.

If you connect the cable in the wrong order and the live power cable comes into contact with water, people on board, nearby swimmers and marine life will be exposed to a potentially lethal electric shock.

**⚠ DANGER**

Risk of death, electric shock, injury or fire.

Do not alter shore power cable connectors. Use only cable connectors that are compatible with the shore power inlet on your boat and shore power receptacles.

Disconnect the shore power connection when the system is not in use.

**⚠ WARNING**

Neglecting the necessary safety precautions can risk lives.

Take safety seriously. Remember that you as the driver are responsible for the safety for others.

**⚠ WARNING**

Neglecting the necessary safety precautions can risk lives.

Take safety seriously. Remember that you as the driver are responsible for the safety for others.

**⚠ WARNING**

Risk of fire or explosion.

When replacing parts of the fire-fighting installation only matching components shall be used, bearing the same designation or being equivalent in their technical and fire resistant capabilities.

**⚠ WARNING**

Not heeding the limitations on the builder's plate can put you and your passengers at risk.

Do not exceed the maximum permitted engine power or number of persons on board.

Respect the conditions set out by the design category of your boat.

**⚠ WARNING**

Not respecting the design category limitations of your boat can put you and your passengers at risk.

Do not exceed the maximum permitted engine power or number of persons on board.

Ensure that the anticipated wind and sea conditions correspond to the design category of your boat.

Always make sure your boat and your operating skills match the weather and water conditions where you are going to operate.

**⚠ WARNING**

Any change in the weight distribution may significantly affect the stability, trim and performance of the boat.

When loading the boat, never exceed the maximum recommended load. Always load the boat carefully and distribute loads appropriately to maintain design trim (approximately level). Avoid placing heavy weights high up.

Take into account any modifications that may affect weight distribution, such as a different engine or a fishing tower.

**⚠ WARNING**

Getting entrapped in the cabin and not having quick access to safety equipment can be fatal in case of flooding.

Never lock or block the access to the emergency exits or safety equipment.

Do not store luggage or other heavy items on top of the front deck hatch.

**⚠ WARNING**

Getting water into the hatches or inside the boat increases the risk of flooding.

Always keep hatches closed and side terraces in upright position when under way.

**⚠ WARNING**

Getting water inside the boat increases the risk of flooding.

Keep seacocks closed when not needed for operation to minimize the risk of flooding (for example water inlet of toilet flushing line).

**⚠ WARNING**

Risk of fire or explosion.

Handle open flame and fuel-driven devices with caution.

**⚠ WARNING**

Careless refueling is a fire hazard.

Never fill the fuel tank or handle fuel when the engine is running.

Don't smoke when handling fuel.

**⚠ WARNING**

Trying to cope by yourself too long can quickly escalate an emergency.

In case you cannot handle the situation, always contact rescue service without delay!

**⚠ WARNING**

Risk of drowning! The boat can sink or capsize if too much water gets into the boat.

Do not rely solely on the bilge pump system. It is not designed to pump out large amounts of water.

**⚠ WARNING**

Risk of injury.

Do not use the outboard engine's cavitation plates for reboarding.

**⚠ WARNING**

Risk of explosion.

Never use water to put out fuel fire. If the fire gets in touch with a flammable fuel, water can spread the fire and cause an explosion.

**⚠ WARNING**

Carbon monoxide (CO) is harmful to your health in higher concentrations, and can even be lethal. Even low concentrations of CO can cause damage with prolonged exposure.

Prevent the accumulation of CO in the first place by minimizing the risk situations.

Act quickly if the CO alarm turns on or if you suspect CO poisoning.

**⚠ WARNING**

Poor trimming can risk lives! Adjusting the trim angle at high speeds may radically affect your boat's behavior. A high running trim can obstruct the view so you may not notice swimmers and small vessels.

Avoid making adjustments at high speeds.

Don't drive with the bow high for long periods of time. Trim the boat's vertical angle to lower the attitude in congested areas.

**⚠ WARNING**

Overcorrecting, dropping the speed suddenly or hitting the waves at a wrong angle when driving at high speeds can have serious consequences.

Do not exceed your boating capabilities. Drive at speeds you are comfortable with. Avoid sudden maneuvers.

Always use the lanyard stop switch.

**⚠ WARNING**

Risk of death, electric shock or injury.

Working on the electrical installation while the system is energized can cause an electric shock.

Never work on the electrical installation while the system is energized.

**⚠ WARNING**

Risk of electric shock or damage to the equipment.

Never alter or modify the rated current amperage of overcurrent protective devices.

**⚠ WARNING**

Risk of electric shock, battery overheating, explosion, fire or harmful gases.

Do not block the battery ventilation.

**⚠ WARNING**

Risk of electric shock, battery overheating, explosion, fire or harmful gases.

Do not use external charger on the boat.

**⚠ WARNING**

Hot engine parts could cause a fire if in contact with flammable materials.  
Store equipment that contains gasoline only in compartments designed for this purpose.

**⚠ WARNING**

The boat can sink if too much water gets into the boat.  
If you suspect a leak, find out the reason and go ashore as soon as possible. The bilge pump system is not designed to pump out large amounts of water.  
If there is a rapid increase in water accumulation, call rescue service.

**⚠ WARNING**

Risk of fire or carbon monoxide accumulation.  
Do not block the heater's exhaust pipe, ventilation or warm air outlet.

**⚠ WARNING**

Risk of fire or overheating.  
Do not close the lid of the wet bar when the cooktop is hot.

**⚠ WARNING**

Risk of death or serious injury.  
Failure to lock the seat can cause you to be ejected from the seat.  
Lock the cockpit seat when you drive.

**⚠ WARNING**

Risk of injury, falling overboard or material damage.  
Make sure there are no people or objects near or on the side terraces when you lower or lift them. Always lower the side terrace to the lowest locking position.  
Lift the side terraces before you move the boat. It is prohibited to drive the boat unless the side terraces are locked in upright position.

**⚠ WARNING**

Risk of serious injury or material damage.  
The water ski pole and its mounting may tear off and cause damage and injury.  
Use the pole only for water skiing. Do not use it for towing other boats, vessels or water toys.

**⚠ WARNING**

A rotating propeller may cause death or a serious injury.  
Shut off the engine when there are people in the water near the boat.  
Do not reboard the boat when the engine is running.  
Do not use the engine's cavitation plates for reboarding the boat.

**⚠ CAUTION** Risk of injury or material damage.

The owner is responsible for ensuring that the normal mode of operation is maintained. This means that the speed of the craft needs to be matched to the prevailing sea state, the craft being used with good seamanship behavior.

**⚠ CAUTION** The boat may tip or the lifting straps may slide during lifting if the straps are not attached properly or if the loads move and disturb the balance of the boat.

Empty the bilge and waste water tanks and remove any unnecessary load from the boat. Do not hook the boat through the aft wings as the straps may slide away.

**⚠ CAUTION** Trailering a large load can be a traffic hazard.

Use a trailer that is suitable for the boat.  
Do not exceed the trailer capacity.  
Secure the boat and the trailer properly.

**⚠ CAUTION** Risk of injury to people, risk of damage to your boat or other vessels.

The protruding fender cleats may collide with people or other boats when driving. Remove the fender cleats before you drive.

**⚠ CAUTION** Risk of electric shock.

Do not touch the batteries or electric connections.

**⚠ CAUTION** Risk of electric shock or damage to the equipment.

Before you reset the fuse, find out why it has tripped.

**⚠ CAUTION** Risk of fire, explosion or material damage.

Avoid damaging the fuel lines on your boat. Pay attention to the location and condition of the fuel lines.

**⚠ CAUTION** Pollution and health hazard.

Do not empty the waste water tanks into the water.  
Plan your voyage in a way that you can always reach shore with proper fixed waste water tanks in good time before your waste water tanks get filled.

**⚠ CAUTION** Risk of injury or material damage.

Always lift the anchor up and secure it in the anchor box or lock it in the retaining system when you are not using the anchor.

**⚠ CAUTION**

Risk of boat tipping or side terrace breaking down, risk of people or property falling into the water.

Always remember the balance of the boat and the durability of the side terrace.

Do not allow too many people to stay on the lowered side terrace.

Do not place too much load on the lowered side terrace.

Do not exceed the maximum permitted load on the side terraces. Check the technical specification for the maximum permitted load.

**⚠ CAUTION**

Risk of injury or material damage.

Do not drive the boat when the sun shade is up. The sun shade and mounting poles may tear off.

Do not use the sun shade in harsh weather conditions and in strong wind.

**⚠ CAUTION**

Risk of injury or material damage.

Do not attach the water ski rope to cleats or other parts of the boat.

**⚠ CAUTION**

Risk of injury or material damage.

Do not lock or block the bathing ladder hatch.

Do not drive the boat when the bathing ladder is down.

**⚠ CAUTION**

Risk of injury or material damage.

Do not use the harbor covers when driving. The covers may tear off in strong wind.



Saxdor Yachts cannot be held responsible for modifications not approved by the company.

Always use trained and competent people for maintenance, repair or modifications.

Modifications that may affect the safety characteristics of the boat need to be assessed, executed and documented by competent people.

## 9.5 Glossary

Check here the terms and abbreviations used in the manual.

Table 9.1 - Terms and abbreviations

Term, abbreviation, acronym	Definition
ABYC	American Boat and Yacht Council
Aft, AFT	The rear of the boat
Aftdeck	Deck area in the rear part of the boat, social area
AIS	An automatic identification system (AIS) transponder which automatically provides position, identification and other information about the boat to other ships and to coastal authorities
	Aquatic Invasive Species. Plants, animals or microbes that have been classified as harmful by the ABYC if they spread from a body of water to another body of water.
ANSI	American National Standards Institute, the main organization supporting the development of technology standards in the United States
Auxiliary, Aux	Backup or supplementary equipment, such as auxiliary battery
Beaufort scale, BFT	The measure that relates wind speed to observed conditions at sea or on land
Bilge	Lowest point of the boat's inner hull
Black water	The waste water collected from the toilet.
Bow	The front end of the boat
COLREG	International regulations for preventing collisions at sea
Foredeck	Deck area at the bow of the boat
GPS	Global positioning system
Grey water	The waste water collected from the sinks in the toilet compartment and wet bar, and from the condensate water of the air conditioning unit.
Helm station	Steering station comprising the steering and navigation equipment and the driver's seat
Hull	Boat's frame
ISO	International Standards Organization, the international standard development organization
kN	Kilonewton, unit of force



Term, abbreviation, acronym	Definition
kn	Knot, a unit of speed equal to one nautical mile per hour (1 kn = 1.852 km/h or 1.151 mph)
kW	Kilowatt, unit of engine power (1 kW = 1.34 hp)
MARPOL	International Convention for the Prevention of Pollution from Ships
NMEA	National Marine Electronics Association, a combined electrical and data specification for communication between marine electronics such as echo sounder, sonars, autopilot, GPS receivers and many other types of instruments
Port	Left side of the boat when facing the bow
Starboard, STB	Right side of the boat when facing the bow
Saxdor documentation bag	A satchel including the manufacturer's manuals for the different equipment on the boat
Transom	Vertical section at the stern of the boat
Trim	The relationship of the boat's bow and stern angle to the water. Also known as attitude.
VHF	Very High Frequency radio communication system

## 9.6 Customer satisfaction survey

Please answer the following questions (5 = very satisfied, 1 = not satisfied at all):

	5	4	3	2	1
How satisfied are you with your new boat overall?	<input type="checkbox"/>	<input type="checkbox"/>	<input type="checkbox"/>	<input type="checkbox"/>	<input type="checkbox"/>
How satisfied are you with your new engine overall?	<input type="checkbox"/>	<input type="checkbox"/>	<input type="checkbox"/>	<input type="checkbox"/>	<input type="checkbox"/>
How satisfied are you with your dealer overall?	<input type="checkbox"/>	<input type="checkbox"/>	<input type="checkbox"/>	<input type="checkbox"/>	<input type="checkbox"/>

Other comments:

# SAXDOR

## ROCK THE BOAT INDUSTRY!

### Contact

---

Saxdor Yachts Oy  
Veneentekijäntie 14, 2nd floor  
00210  
Helsinki, Finland

[www.saxdoryachts.com](http://www.saxdoryachts.com)

[hello@saxdor.com](mailto:hello@saxdor.com)